

Handrail

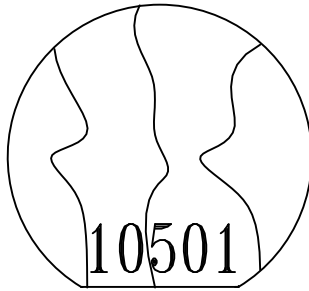

1 5/8

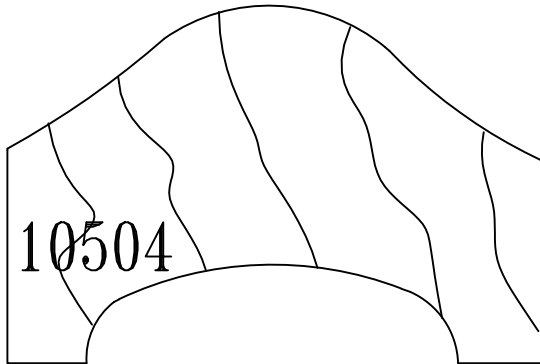

1 3/4 x 2 3/4

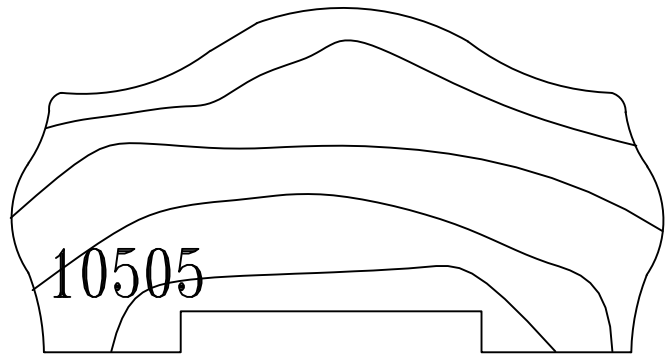

1 3/4 x 3 3/8

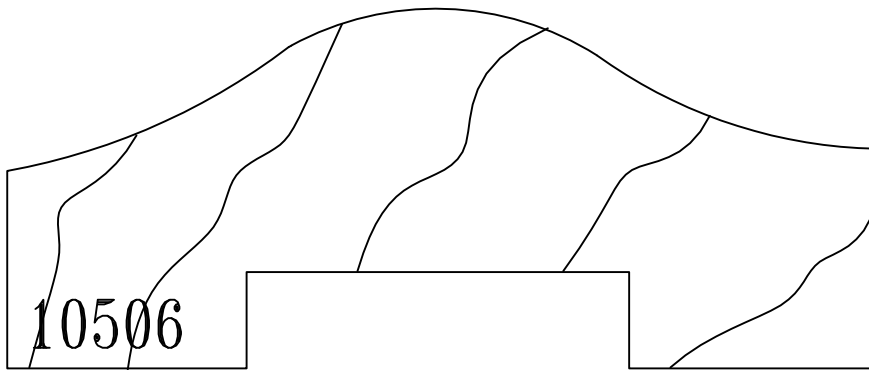

1 3/4 x 4 1/2

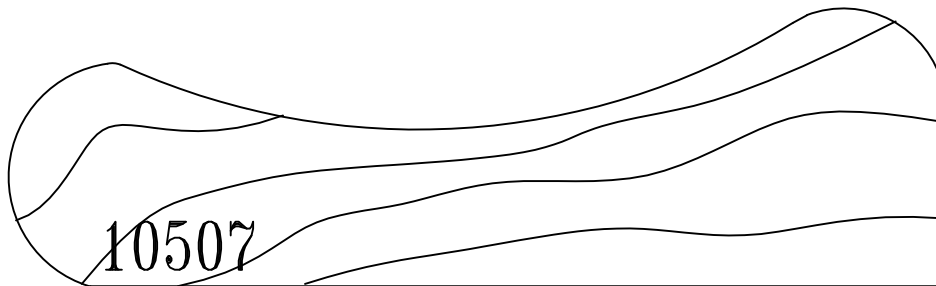

1 3/8 x 5

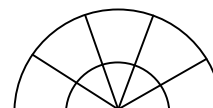

Fraser
Millworks

Handrail

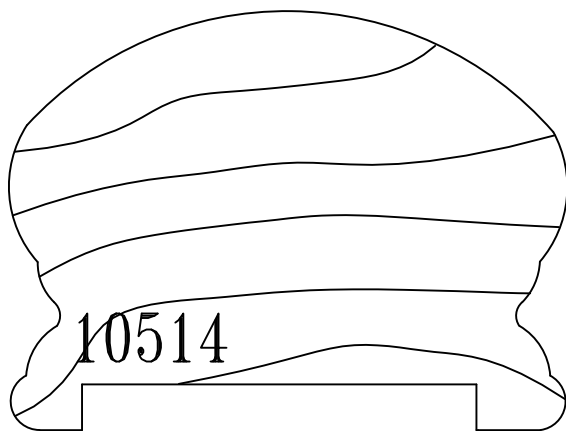
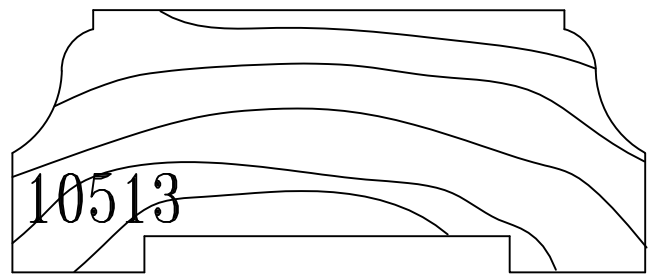
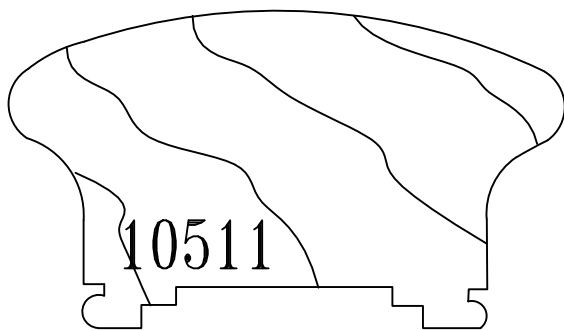
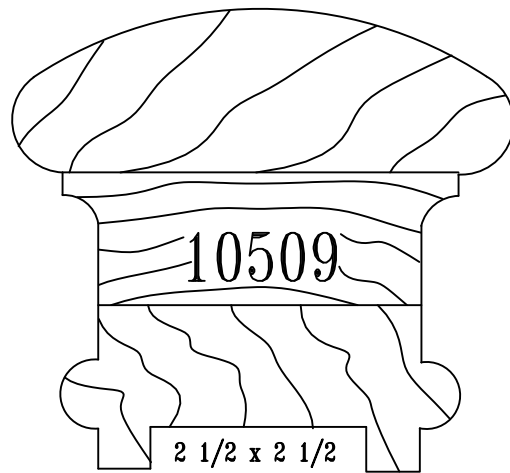
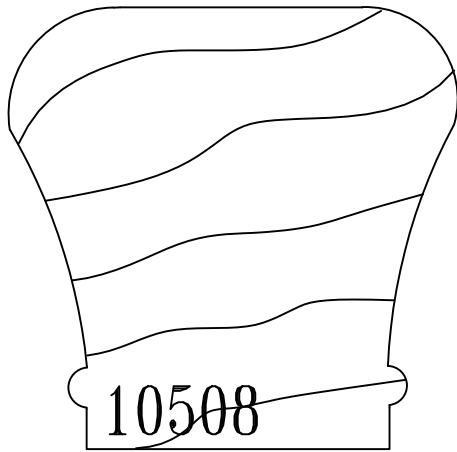

Handrail

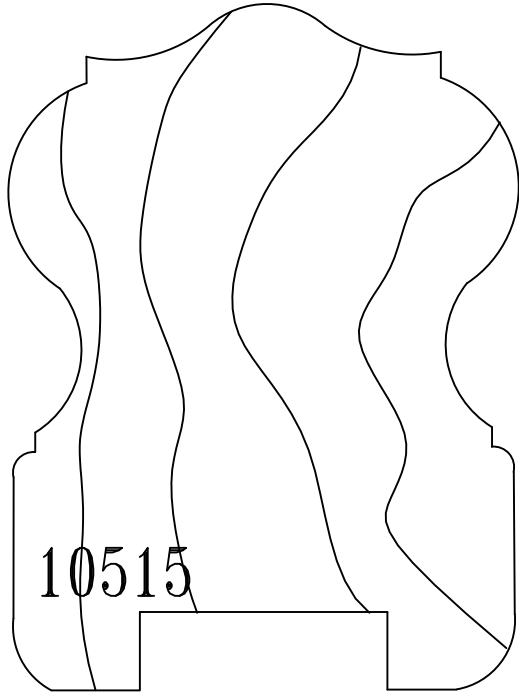

10515

3 1/2 x 2 1/2

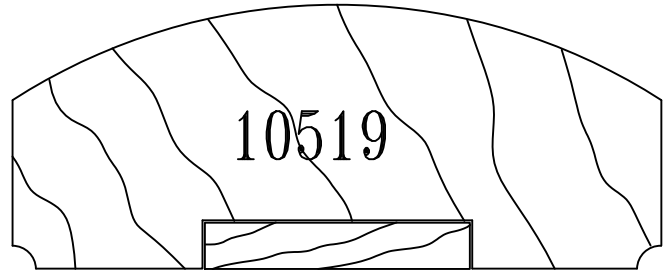

10519

1 3/8 x 3 3/8

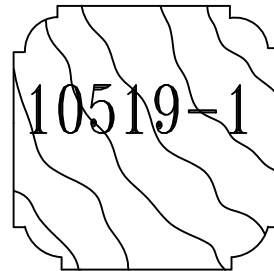

10519-1

1 3/8 x 1 3/8

Baluster detail

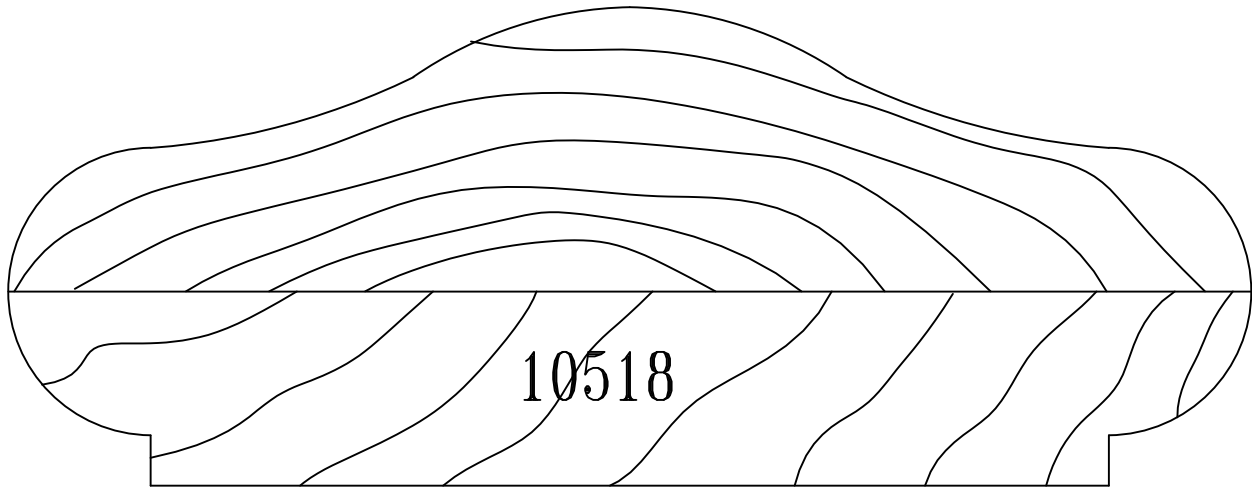

10518

2 1/2 x 6 1/2

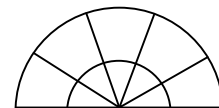

Fraser
Millworks

Handrail

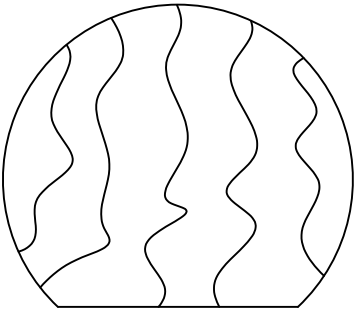

10520

$1 \frac{15}{16} \times 1 \frac{9}{16}$

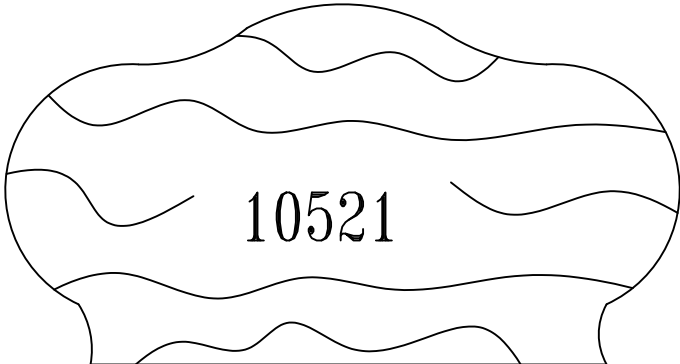

10521

$1 \frac{7}{8} \times 3 \frac{1}{2}$

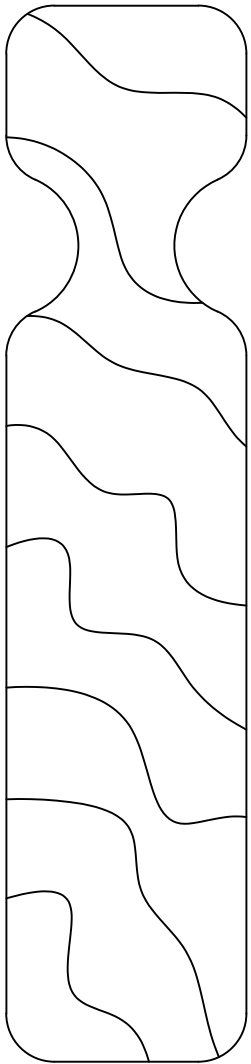

10523

$1 \frac{1}{4} \times 5 \frac{1}{2}$

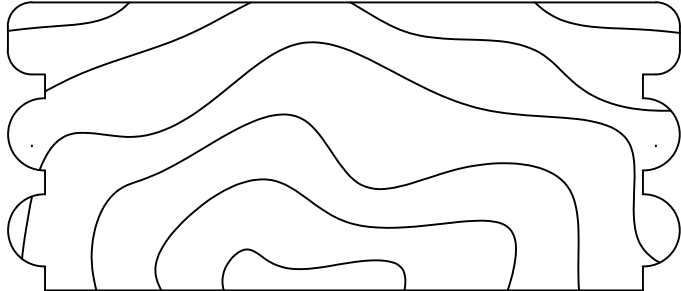

10522

$1 \frac{1}{2} \times 3 \frac{1}{2}$

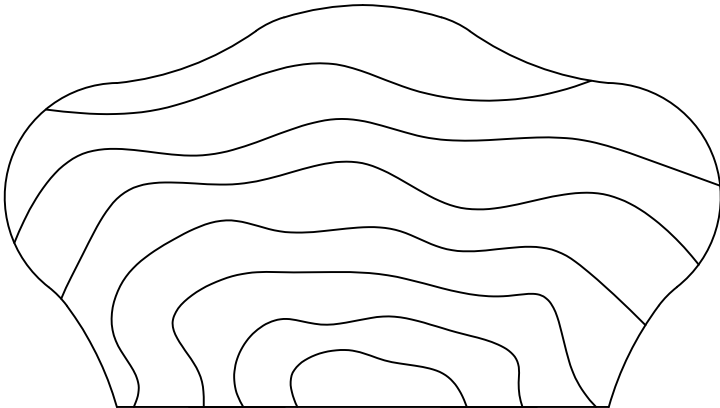

10524

$2 \frac{1}{16} \times 3 \frac{5}{8}$

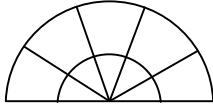

Fraser
Millworks

Handrail

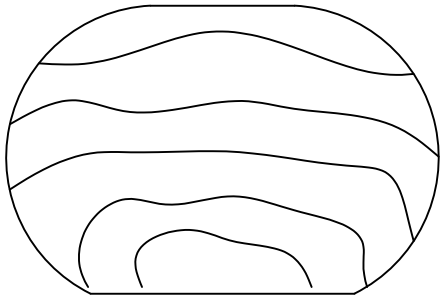

10525

1 1/2 x 2 1/4

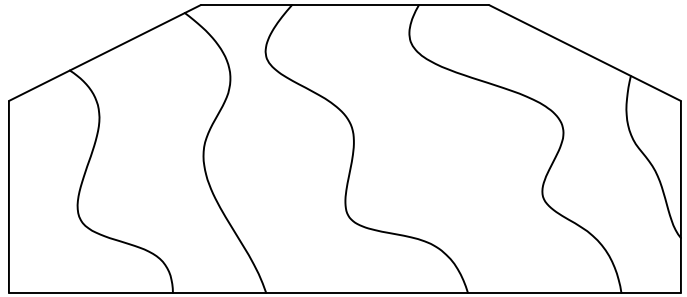

10526

1 1/2 x 3 1/2

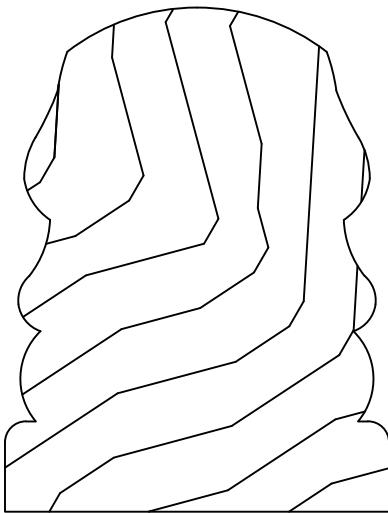

10528

2 5/8 x 2

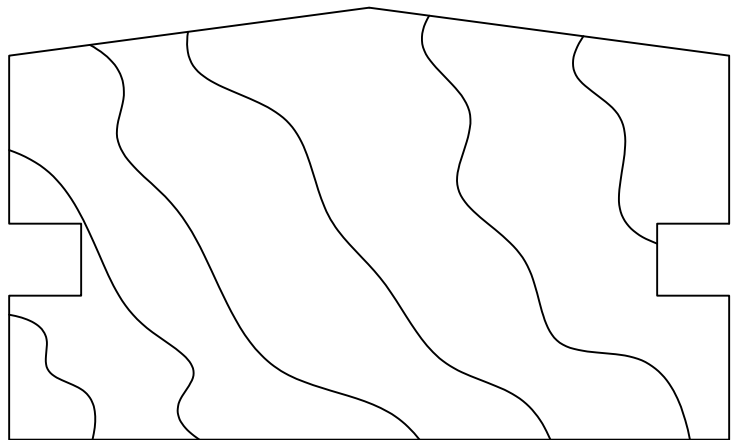

10527

2 1/4 x 3 3/4

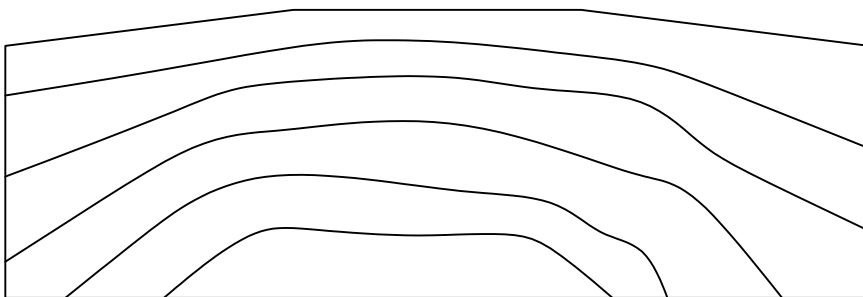

10529

1 1/2 x 4 1/2



Fraser
Millworks

Handrail

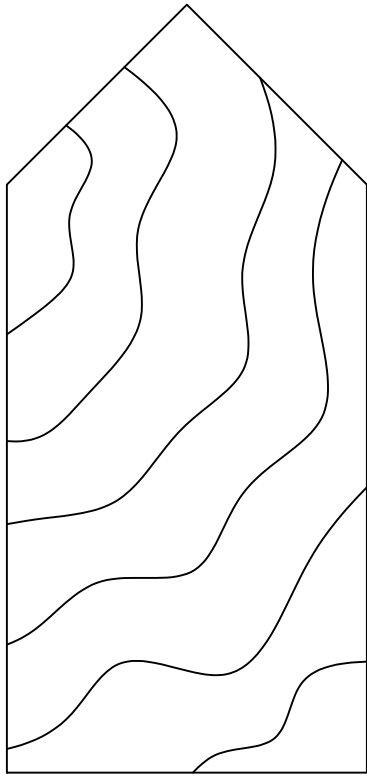

10530
1 7/8 x 4

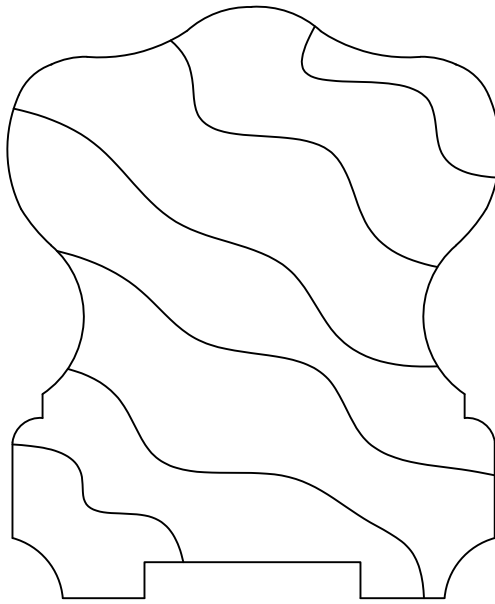

10531
3/4 x 1 1/2



10532
1/2 x 1 3/32
fillet

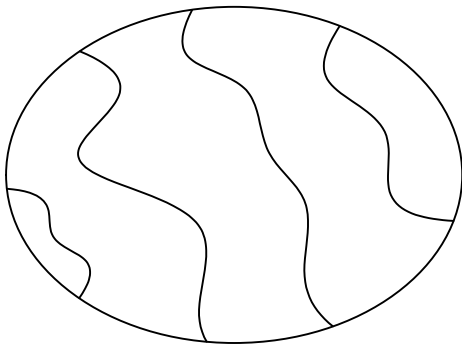

10533
1 3/4 x 2 3/8

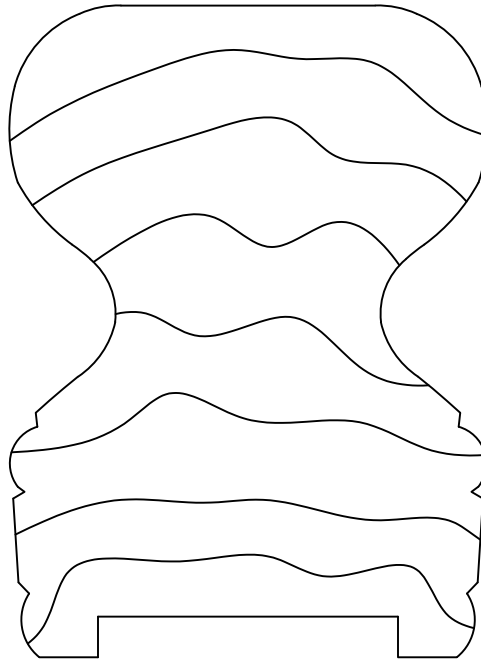

10534
2 1/2 x 3 3/8



Fraser
Millworks

Handrail

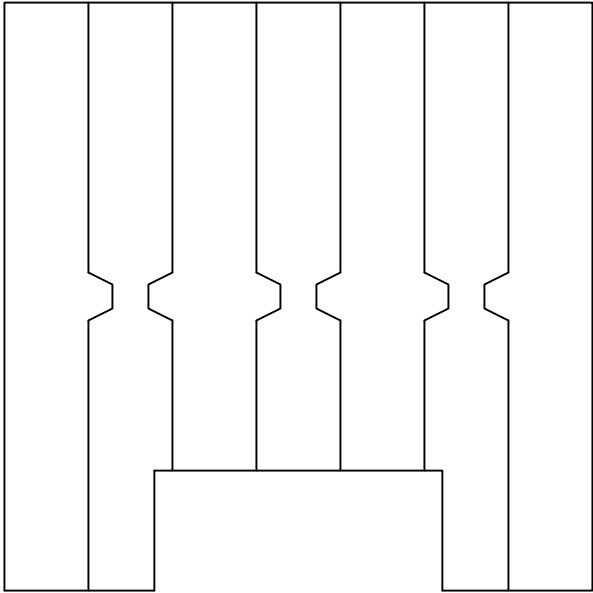

10535
3 1/16 x 3 1/16

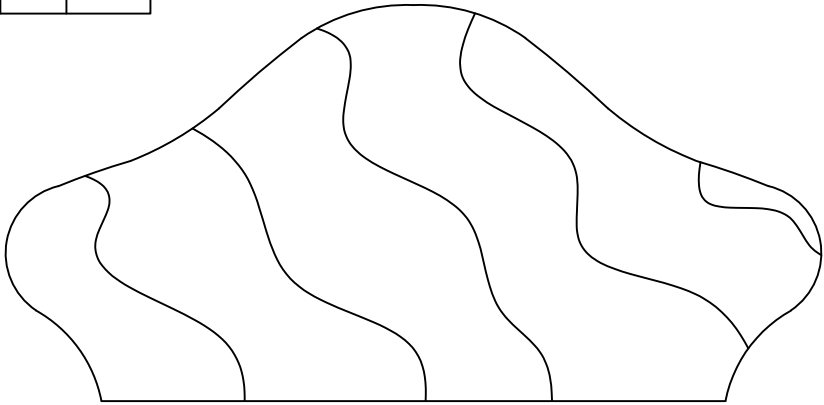

10537
2 1/16 x 4 1/4

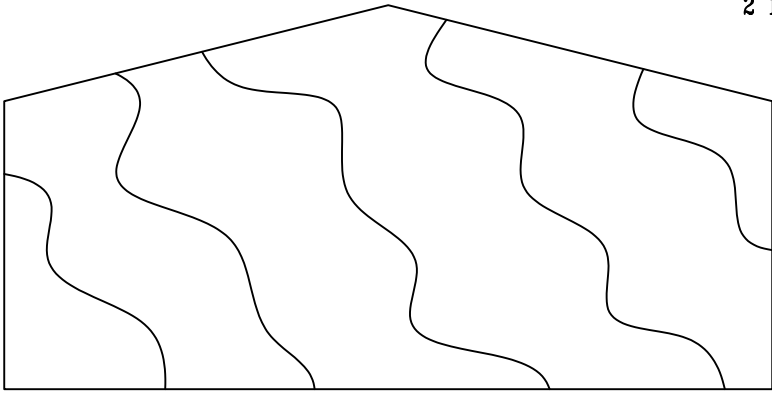

10536
2 x 4



Handrail

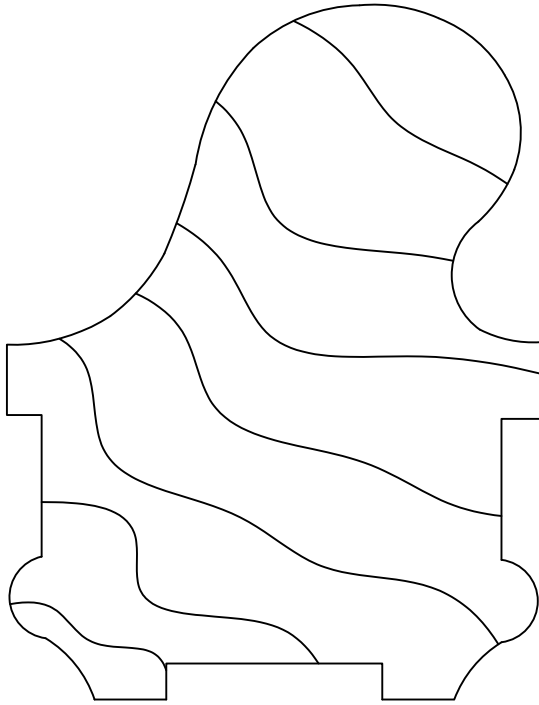

10538
 $2 \frac{3}{4} \times 3 \frac{5}{8}$

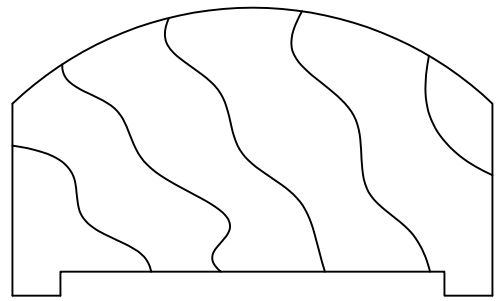

10539
 $1 \frac{1}{2} \times 2 \frac{1}{2}$

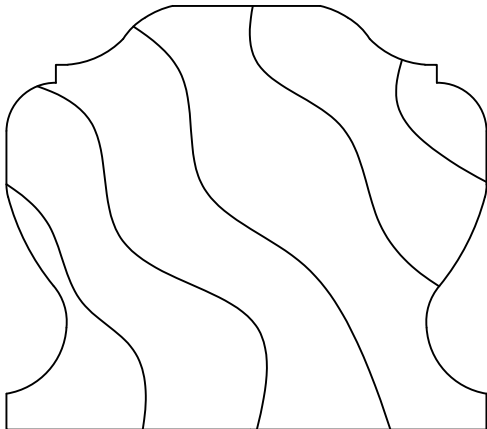

10540
 $2 \frac{3}{16} \times 2 \frac{1}{2}$

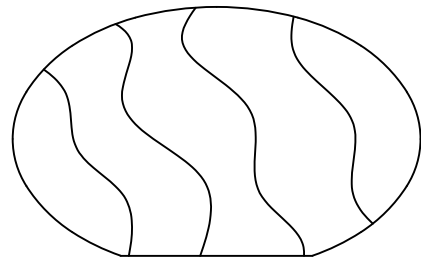

10541
 $1 \frac{5}{16} \times 2 \frac{1}{8}$



Fraser
Millworks

Handrail

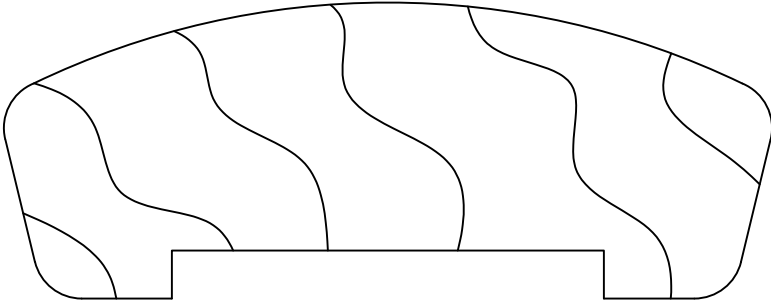

10542
 $1\frac{1}{2} \times 4$

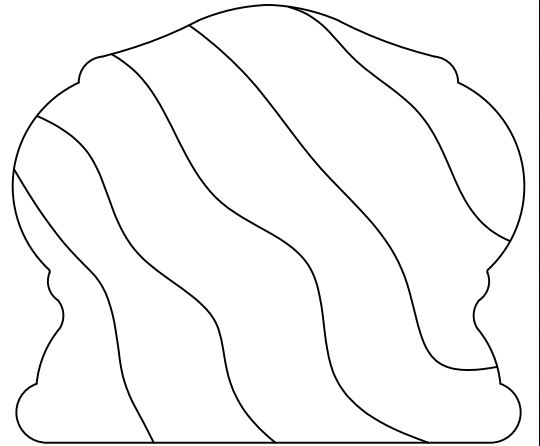

10543
 $2\frac{1}{4} \times 2\frac{5}{8}$

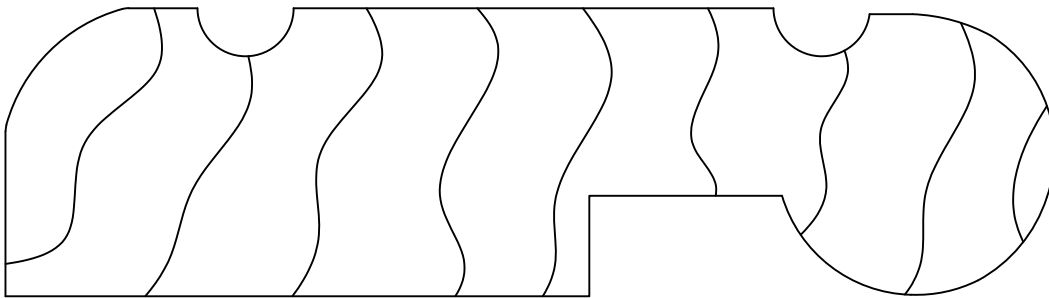

10544
 $1\frac{1}{2} \times 5\frac{7}{16}$

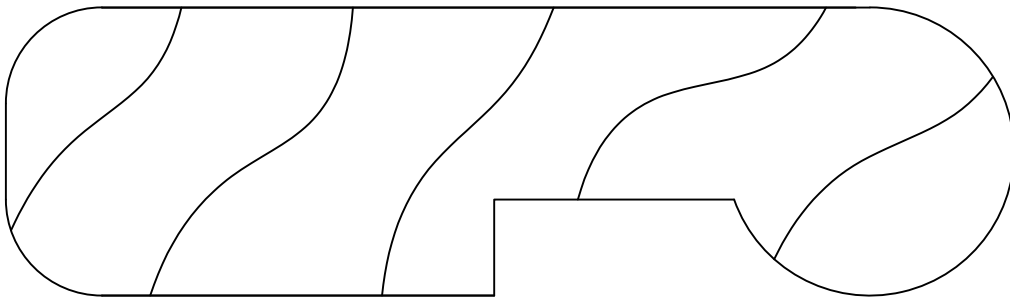

10545
 $1\frac{1}{2} \times 5\frac{1}{4}$



Fraser
Millworks

Handrail

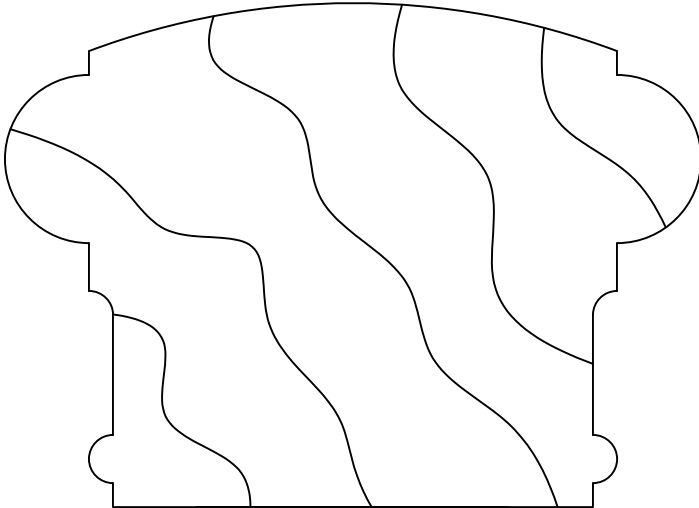

10546
2 5/8 x 3 5/8

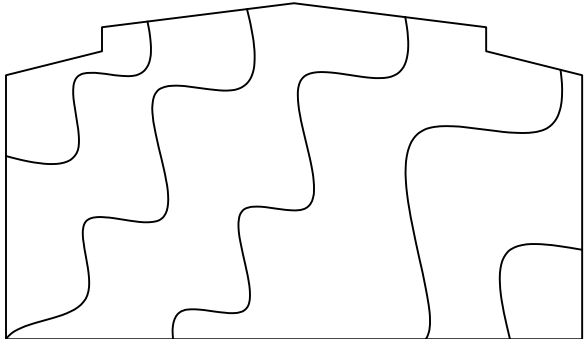

10548
1 3/4 X 3

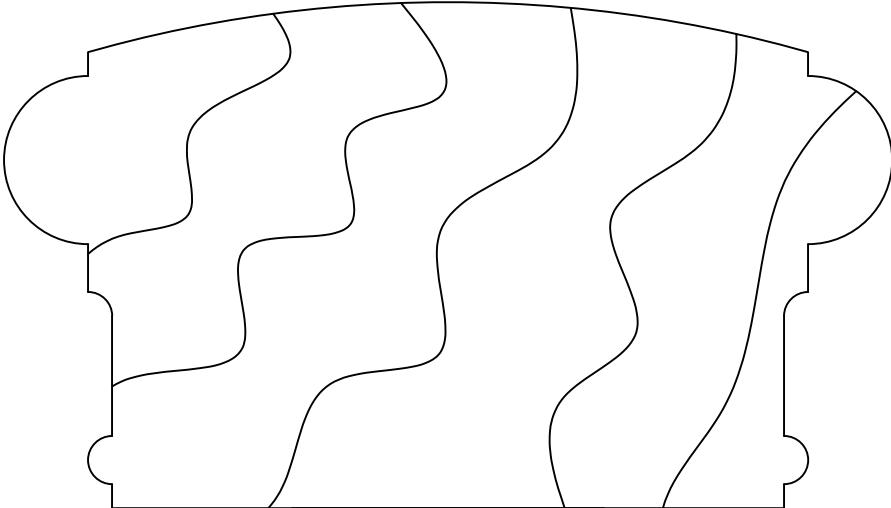

10547
2 5/8 X 4 5/8

Handrail

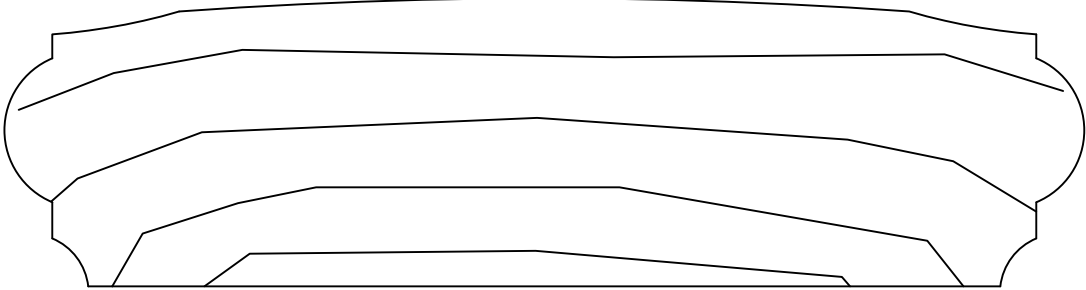

10549
 $1\frac{1}{2} \times 5\frac{5}{8}$

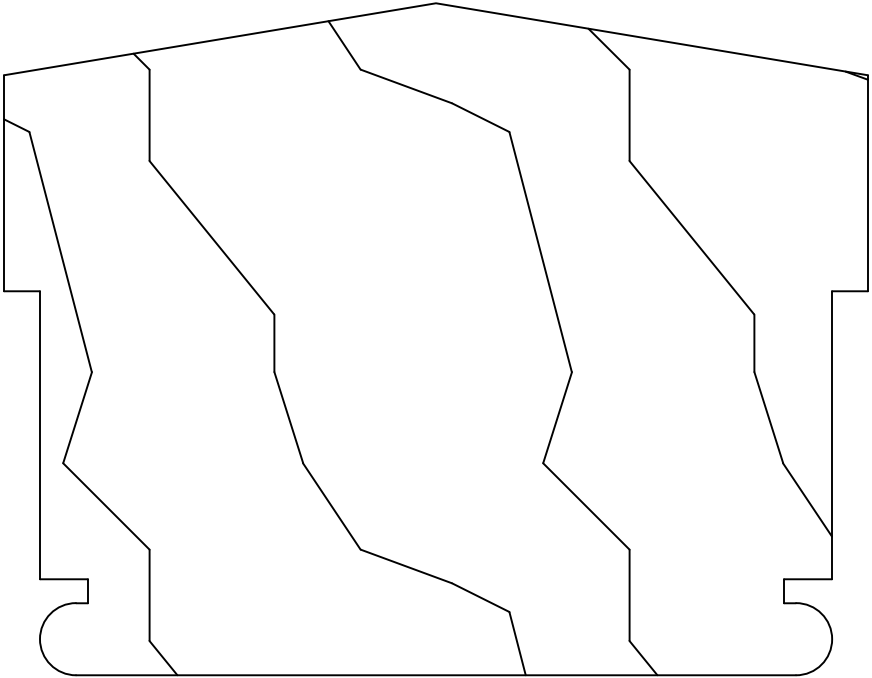

10550
 $3\frac{1}{2} \times 4\frac{1}{2}$

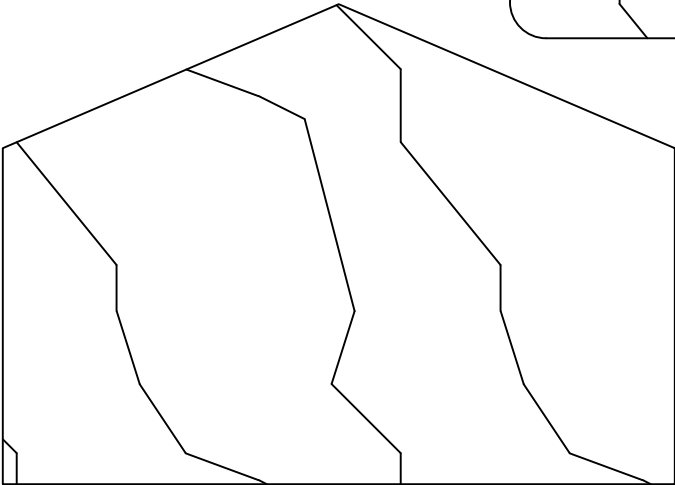

10551
 $2\frac{1}{2} \times 3\frac{1}{2}$



Handrail

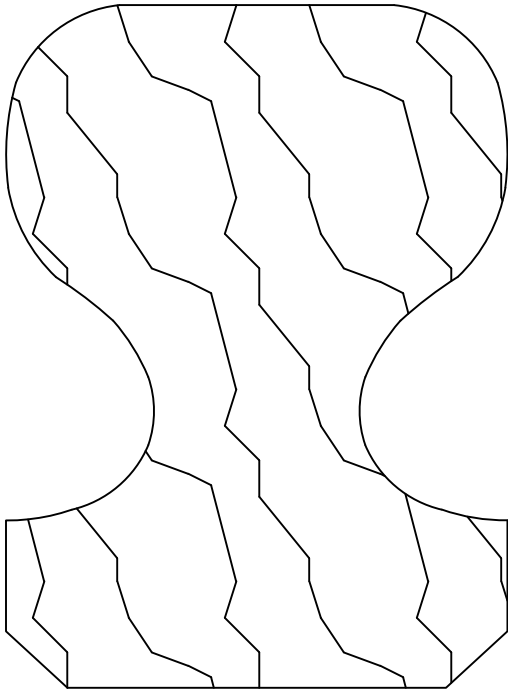

10552
 $3 \frac{9}{16} \times 2 \frac{5}{8}$

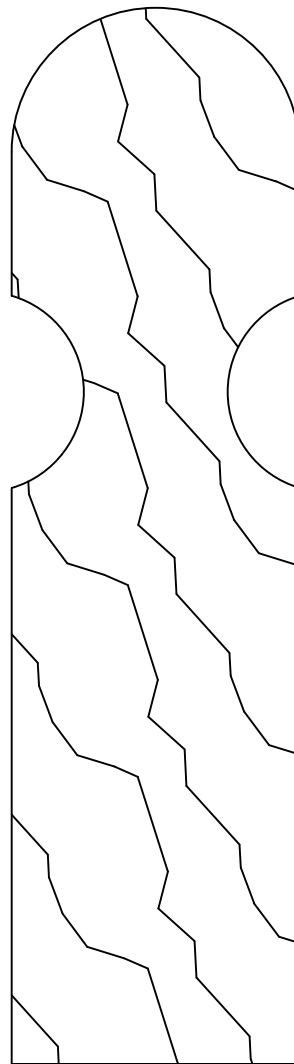

10553
 $1 \frac{1}{2} \times 5 \frac{1}{2}$

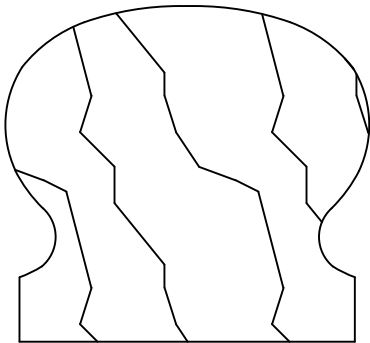

10554
 $1 \frac{3}{4} \times 1 \frac{7}{8}$

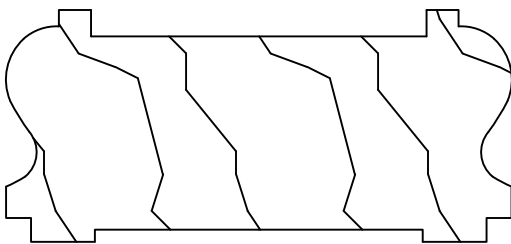

10555
 $1 \frac{3}{16} \times 2 \frac{5}{8}$



Fraser
Millworks

Porch Rail

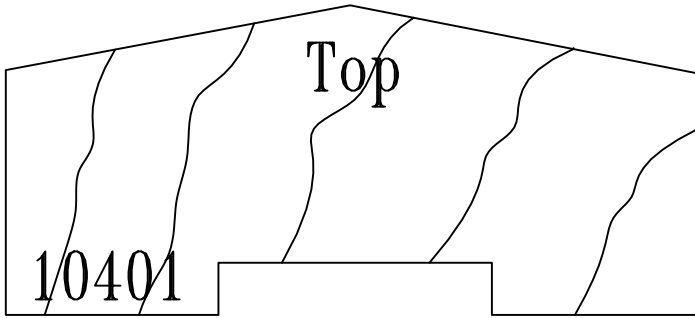

$1 \frac{5}{8} \times 3 \frac{1}{2}$

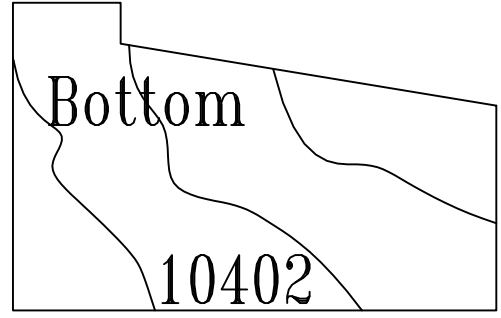

$1 \frac{5}{8} \times 2 \frac{1}{2}$

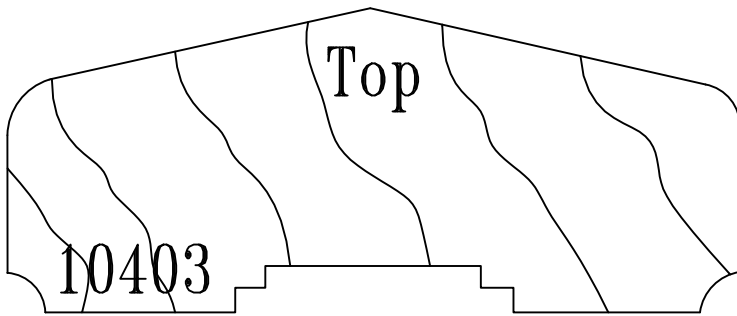

$1 \frac{5}{8} \times 3 \frac{5}{8}$

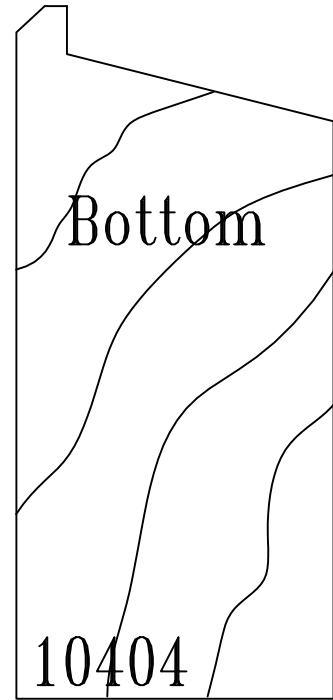

$1 \frac{5}{8} \times 3 \frac{5}{8}$

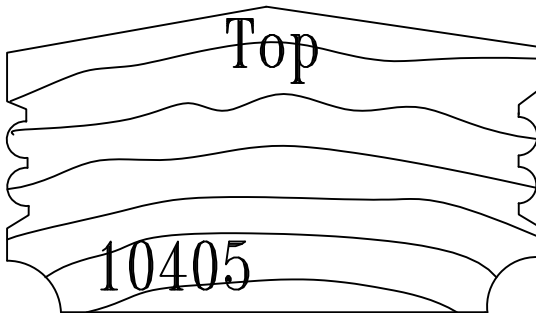

$1 \frac{5}{8} \times 2 \frac{5}{8}, 3 \frac{5}{8}$

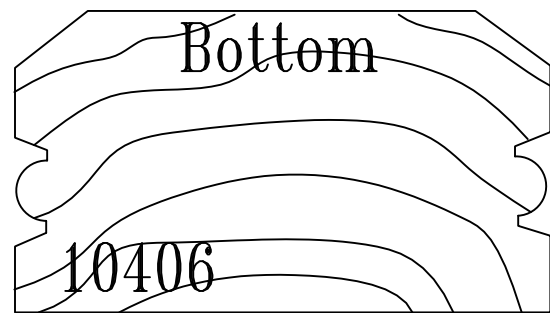

$1 \frac{5}{8} \times 2 \frac{5}{8}, 3 \frac{5}{8}$

Porch Rail

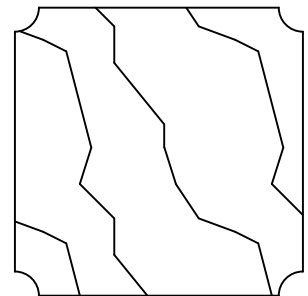
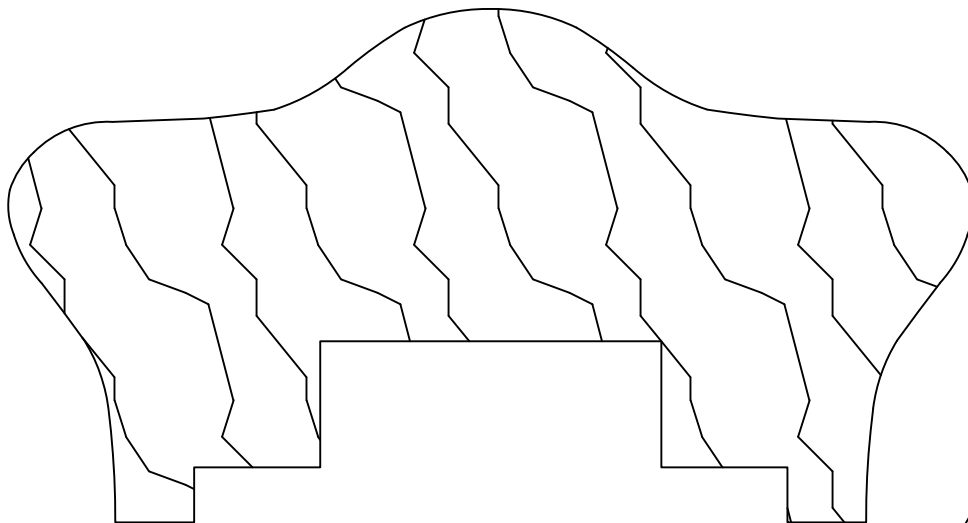
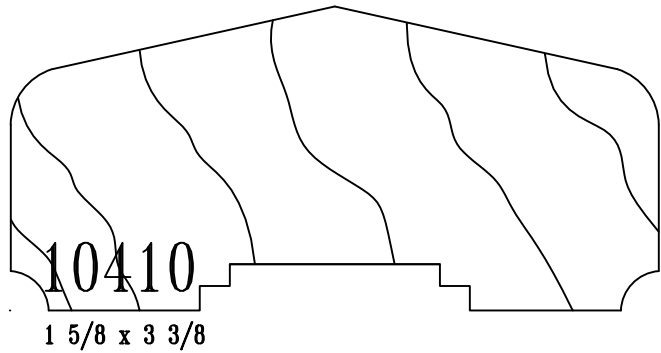
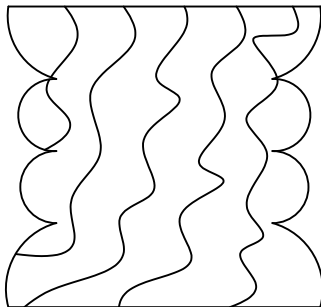
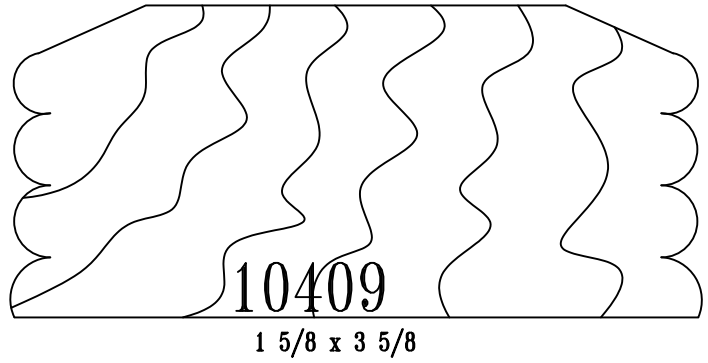
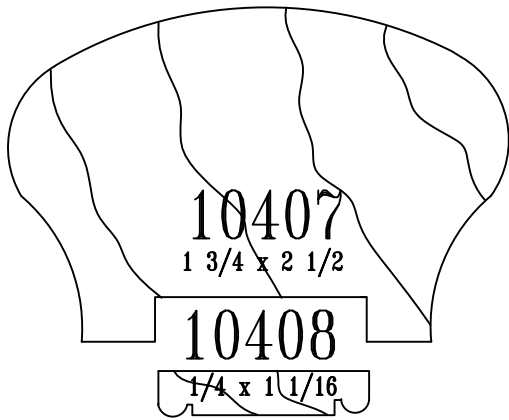

Fraser
Millworks

Porch Rail

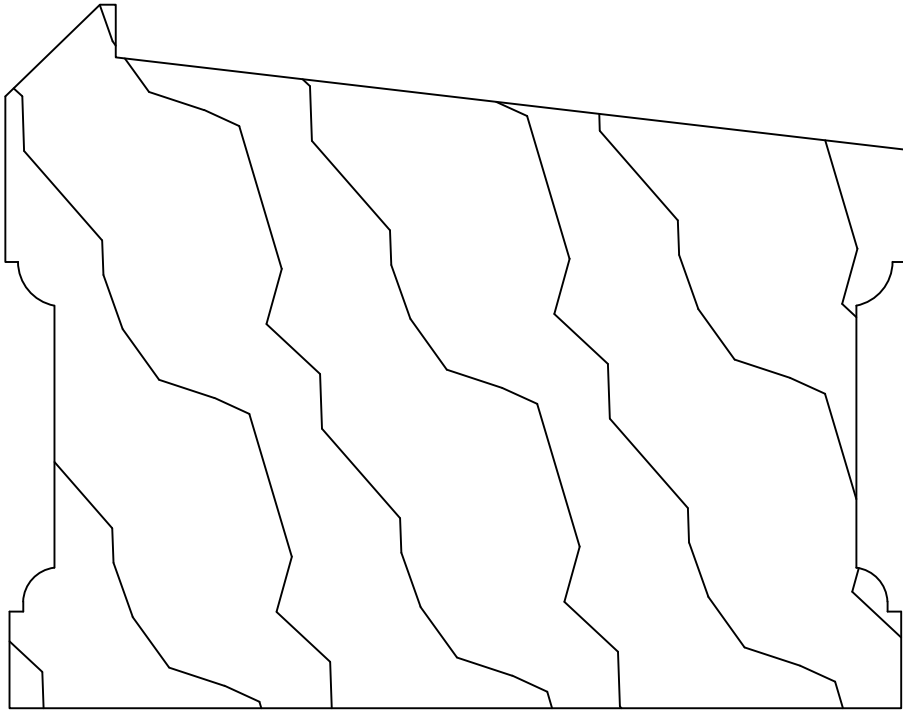

10413
3 5/8 x 4 5/8