

Column Parts

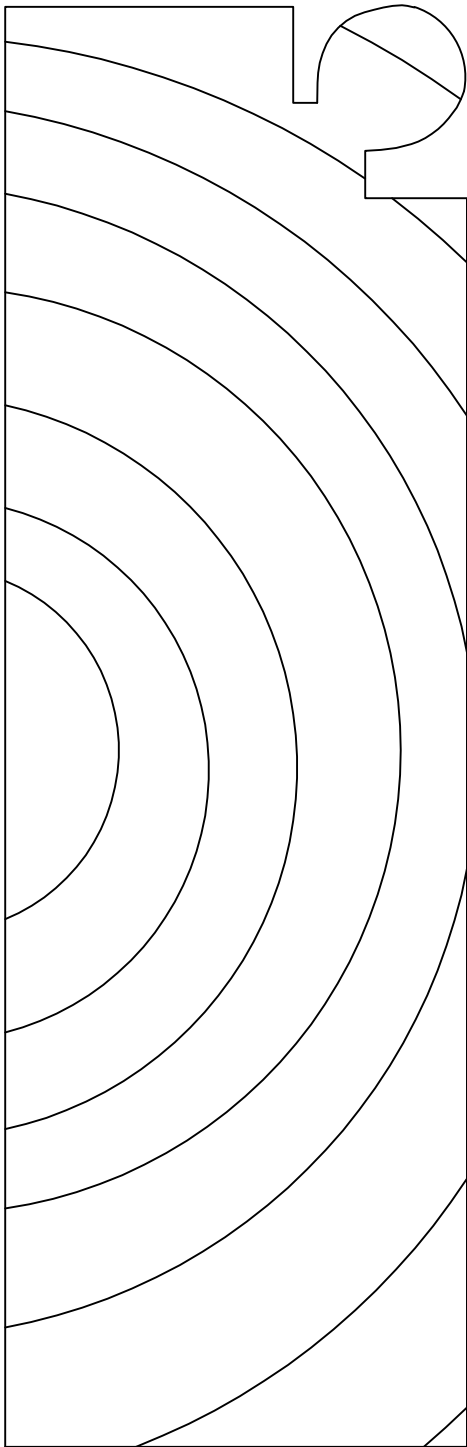

10601

2 7/16 x 7 1/2

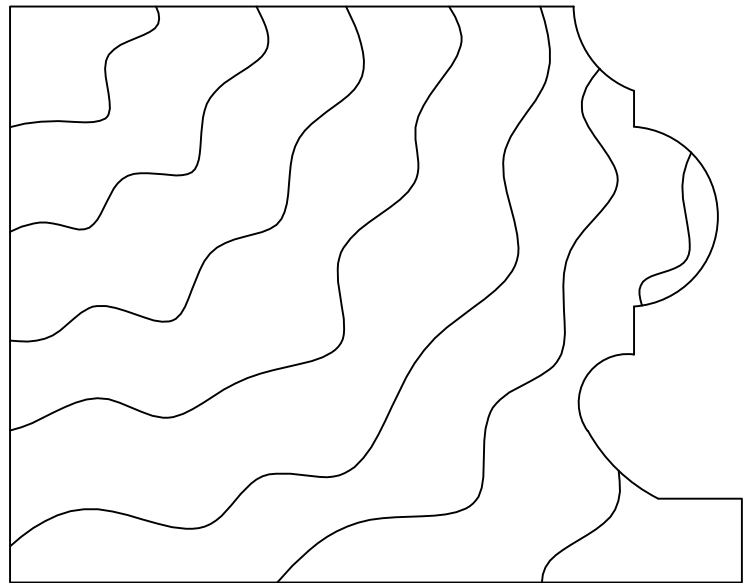

10602

3 x 3 13/16

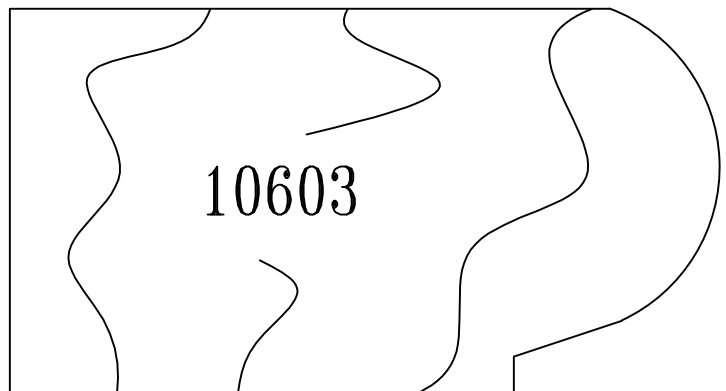

10603

2 x 3 11/16

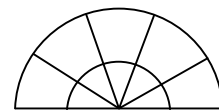

Fraser
Millworks

Column Parts

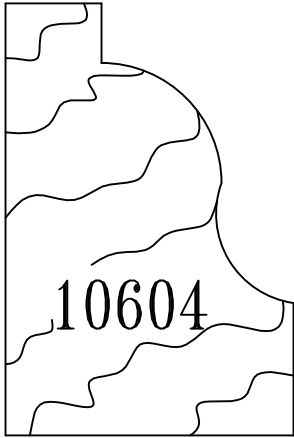

10604

$1 \frac{1}{2} \times 2 \frac{1}{4}$

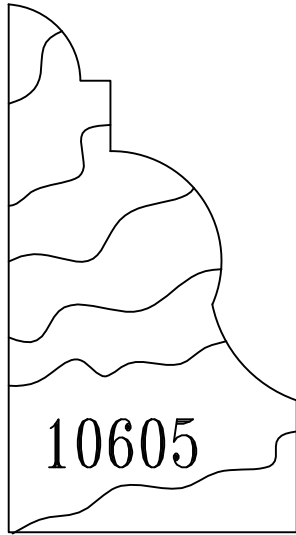

10605

$1 \frac{1}{2} \times 2 \frac{3}{4}$

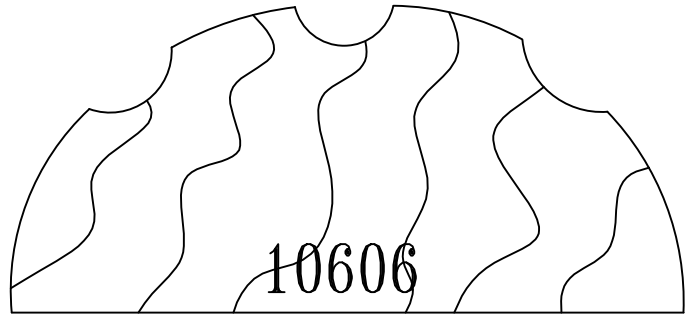

10606

$1 \frac{9}{16} \times 3 \frac{1}{2}$

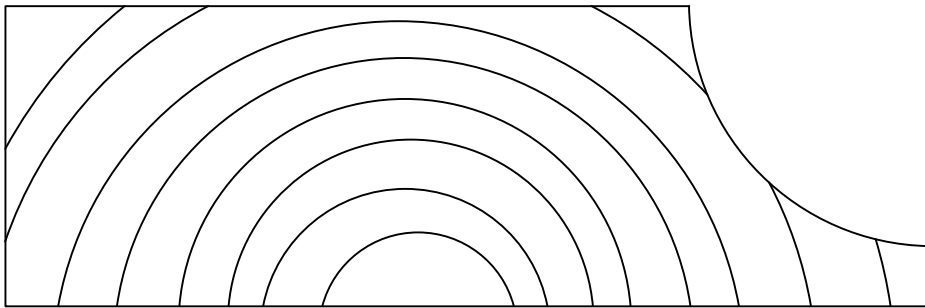

10608

$1 \frac{9}{16} \times 4 \frac{13}{16}$

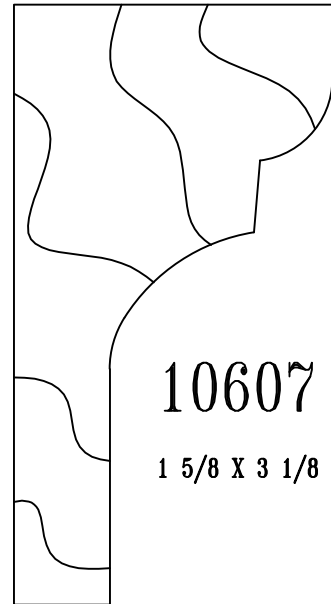

10607

$1 \frac{5}{8} \times 3 \frac{1}{8}$

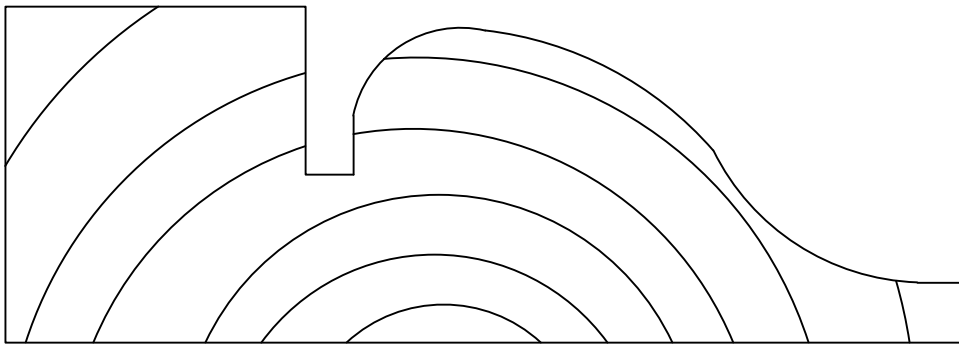

10609

$1 \frac{3}{4} \times 5$



Fraser
Millworks

Column Parts

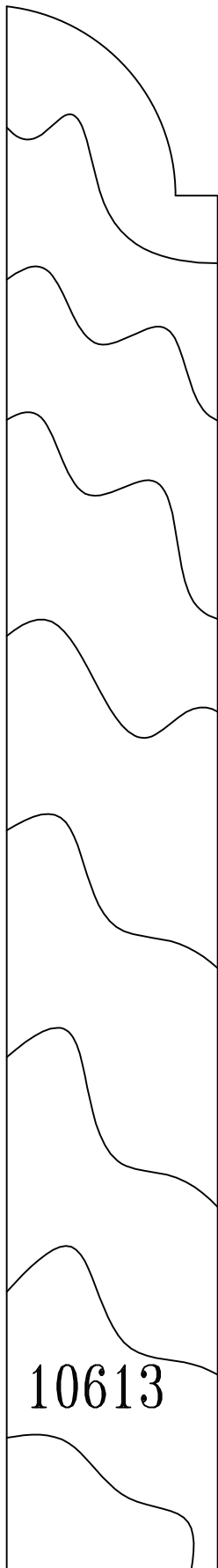

10613

1 1/4 x 9 1/4

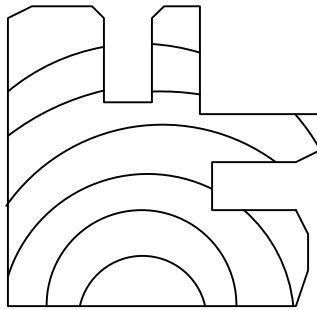

10610

1 9/16 x 1 9/16

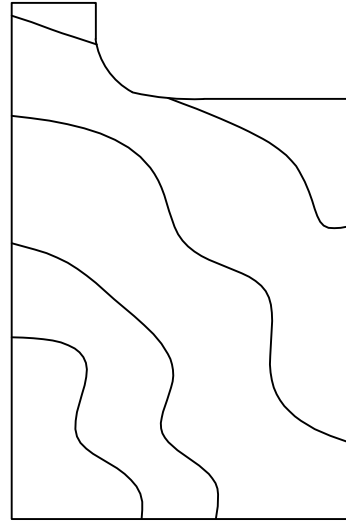

10612

1 3/4 x 2 11/16

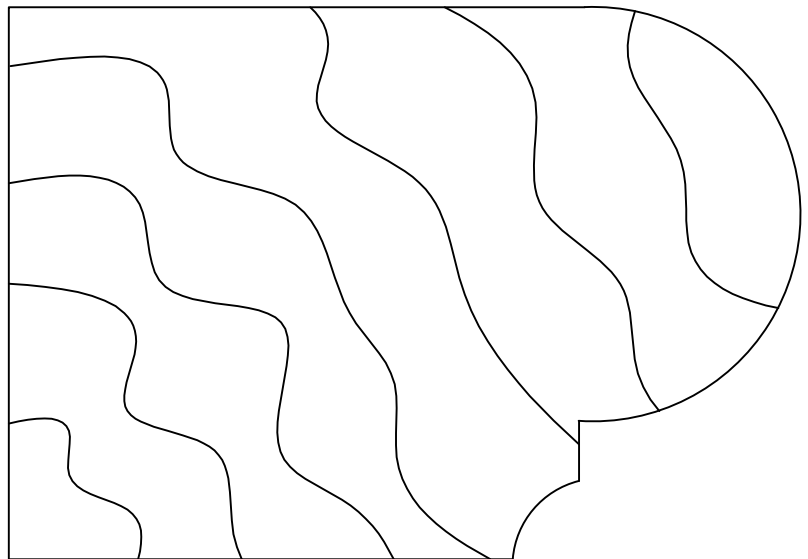

10611

2 7/8 x 4 1/8

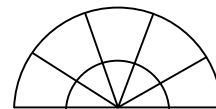

Fraser
Millworks

Column Parts

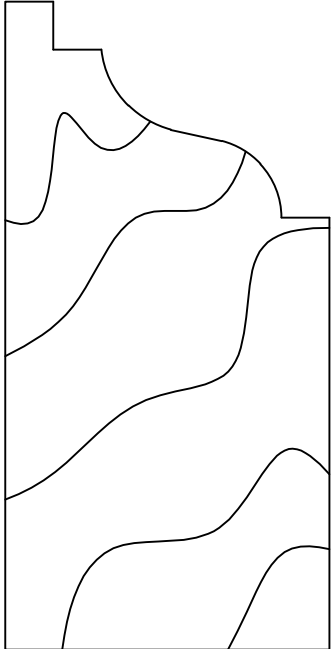

10614

$1 \frac{11}{16} \times 3 \frac{3}{4}$

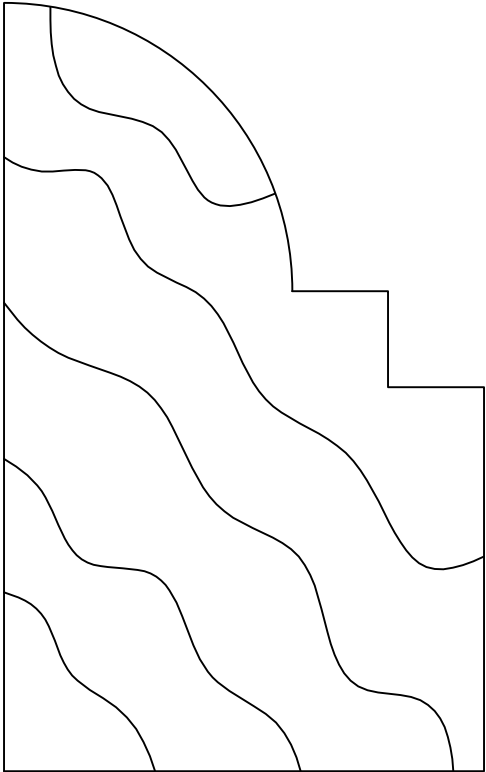

10615

$2 \frac{1}{2} \times 4$

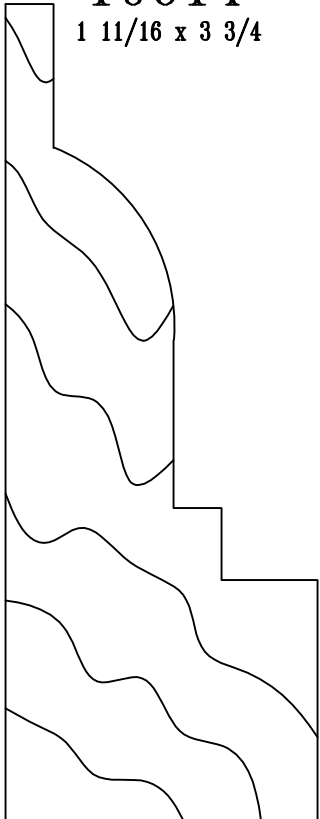

10616

$1 \frac{5}{8} \times 4 \frac{1}{4}$

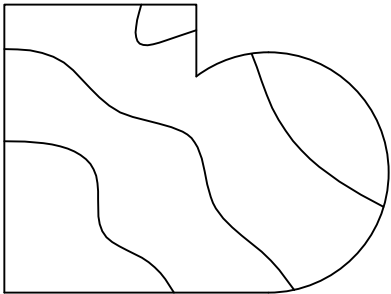

10617

$1 \frac{1}{2} \times 2$

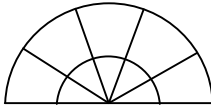

Fraser
Millworks

Column Parts

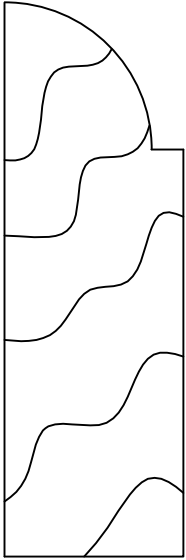

10618
15/16 x 2 7/8

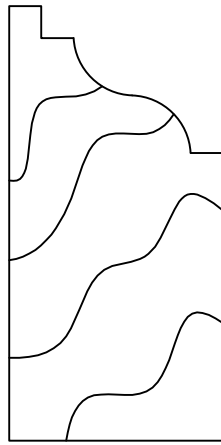

10619
1 1/8 x 2 1/4



10620
11/16 x 1 3/16



10621
7/16 x 2 5/16



10622
5/16 x 3

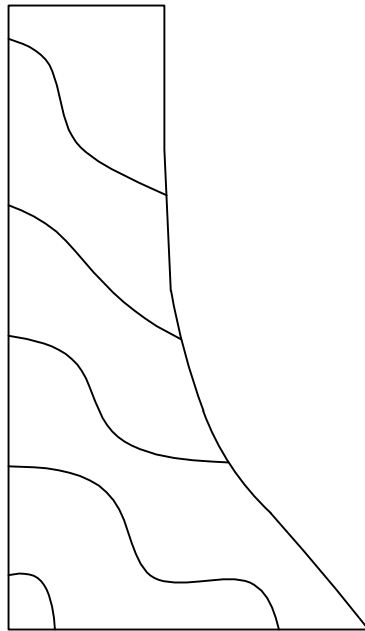

10623
1 7/8 x 3 1/4

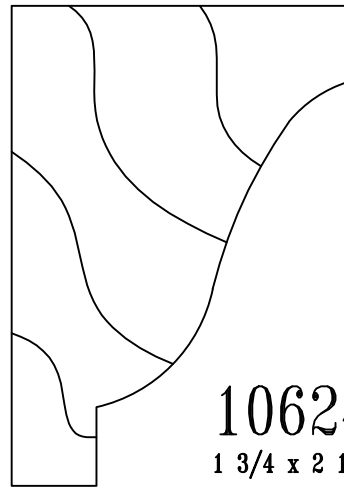

10624
1 3/4 x 2 1/2

Column Parts

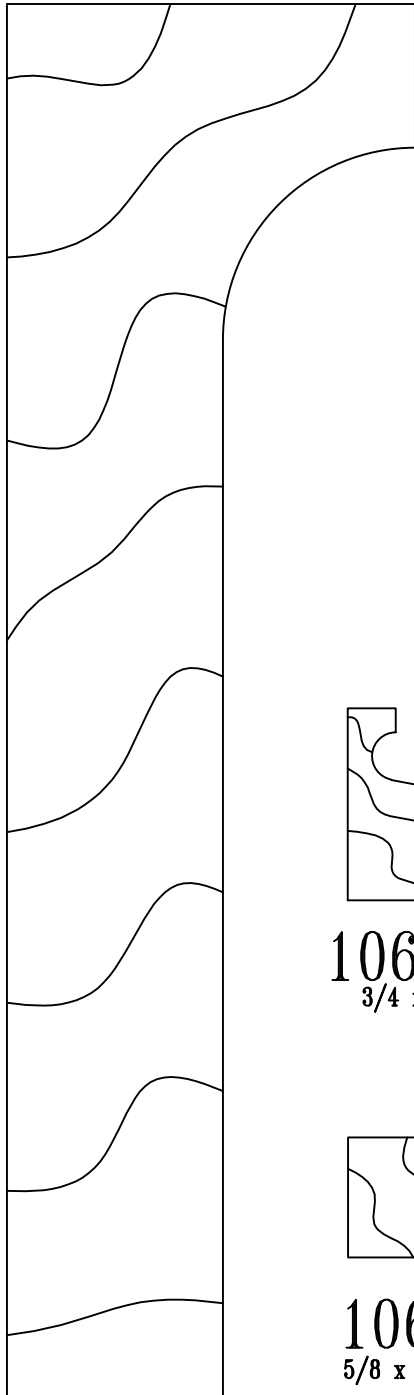

10626

$2 \frac{1}{8} \times 7 \frac{1}{4}$

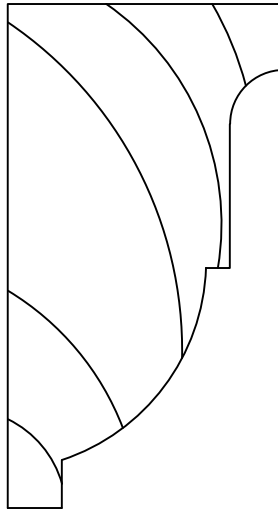

10625

$1 \frac{7}{16} \times 2 \frac{5}{8}$

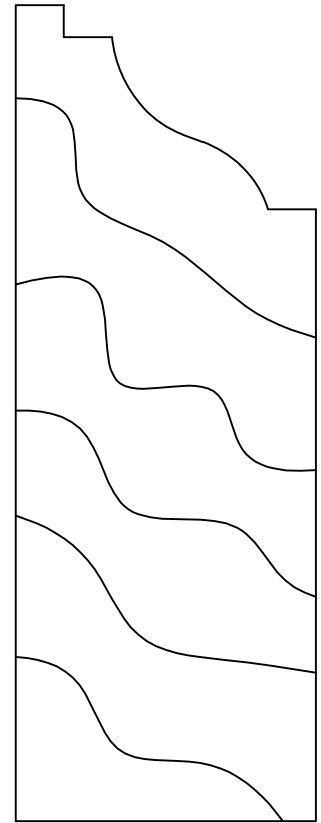

10614-1

$1 \frac{9}{16} \times 4 \frac{1}{4}$

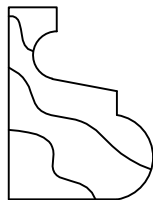

10627

$\frac{3}{4} \times 1$

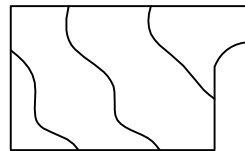

10628

$\frac{3}{4} \times 1 \frac{1}{4}$

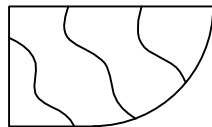

10629

$\frac{5}{8} \times 1 \frac{1}{16}$

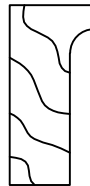

10630

$\frac{7}{16} \times \frac{15}{16}$

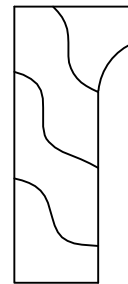

10631

$\frac{5}{8} \times 1 \frac{7}{16}$



Fraser
Millworks

Column Parts

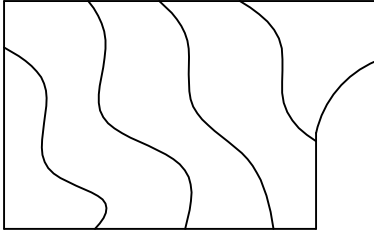

10632
1 3/16 x 1 15/16

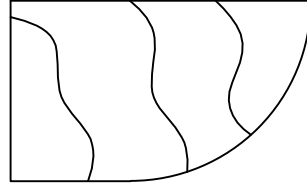

10633
15/16 x 1 9/16

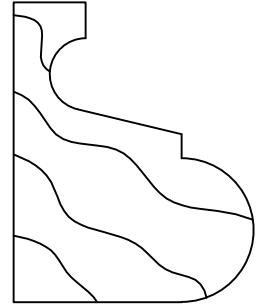

10634
1 1/4 x 1 9/16

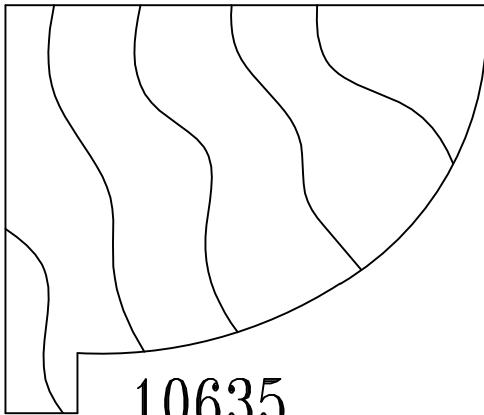

10635
2 1/8 x 2 1/2

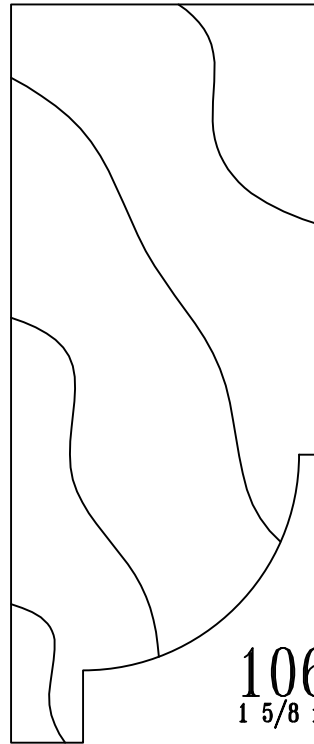

10637
1 5/8 x 3 7/8

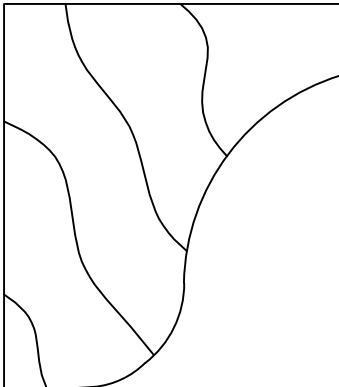

10636
1 3/4 x 2



Fraser
Millworks

Column Parts

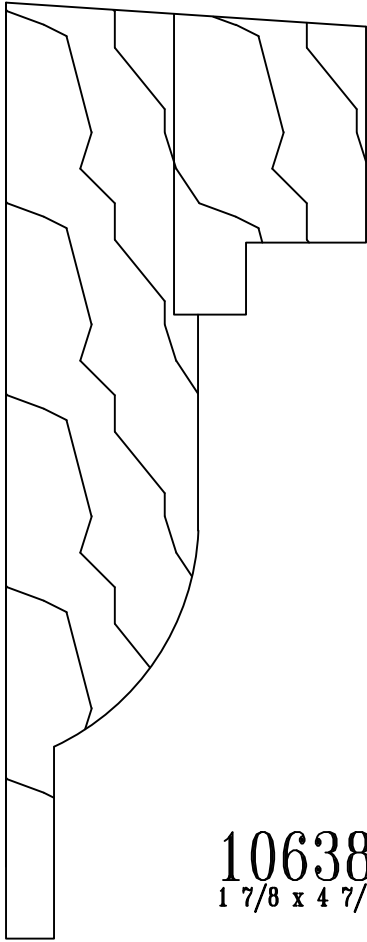

10638
 $1 \frac{7}{8} \times 4 \frac{7}{8}$

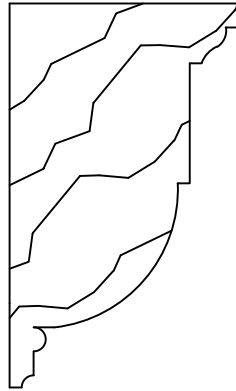

10639
 $1 \frac{3}{16} \times 2$

Bar Rail

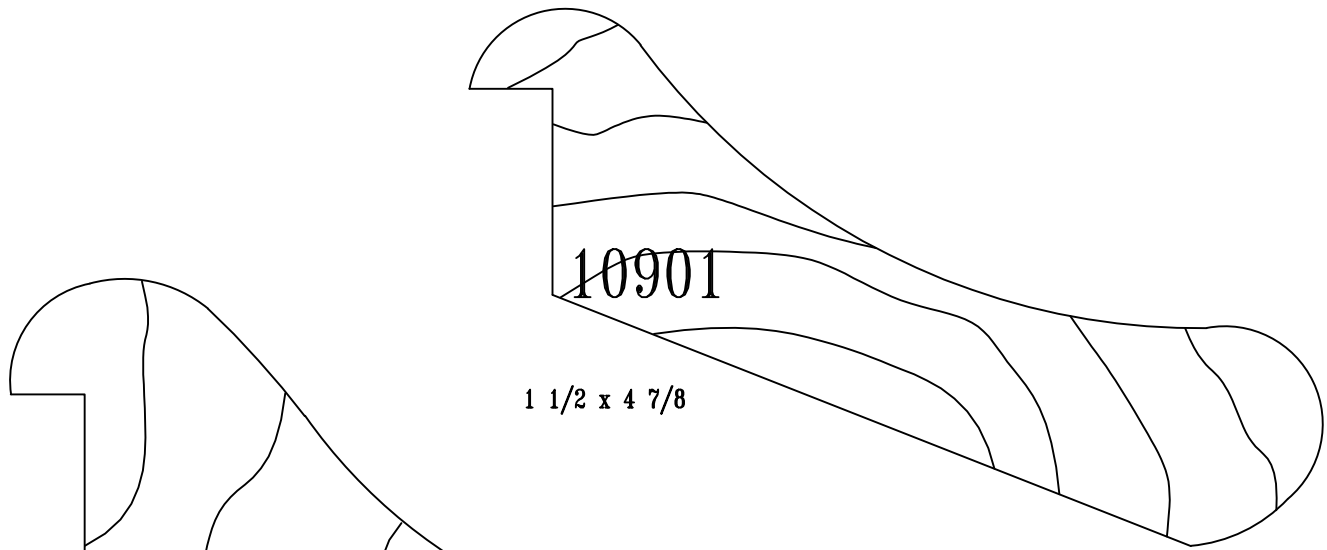

10901

$1\frac{1}{2} \times 4\frac{7}{8}$

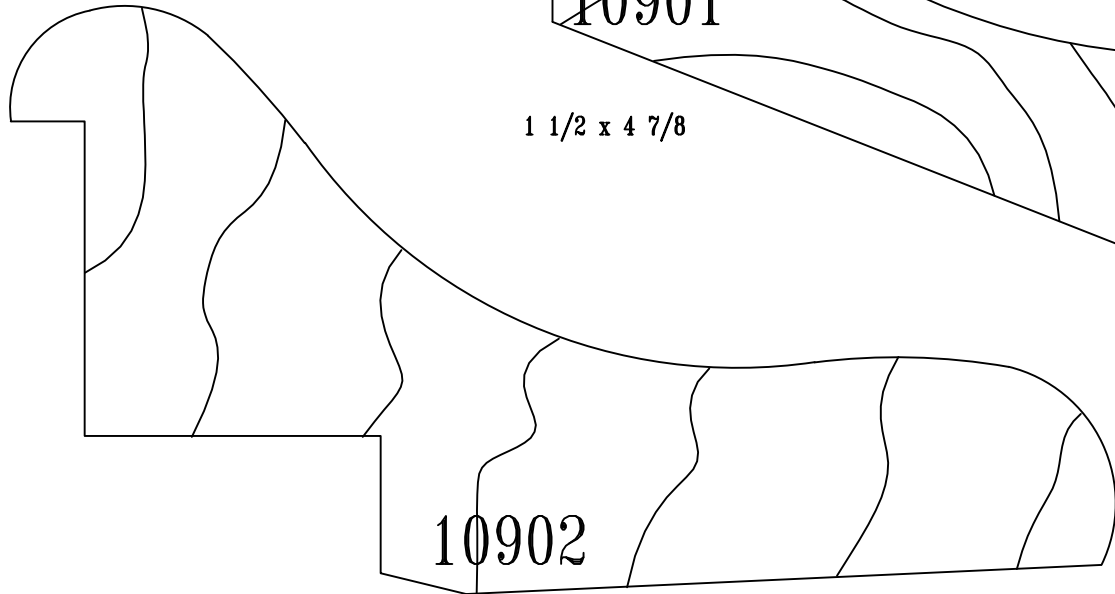

10902

$3\frac{1}{8} \times 5\frac{3}{8}$

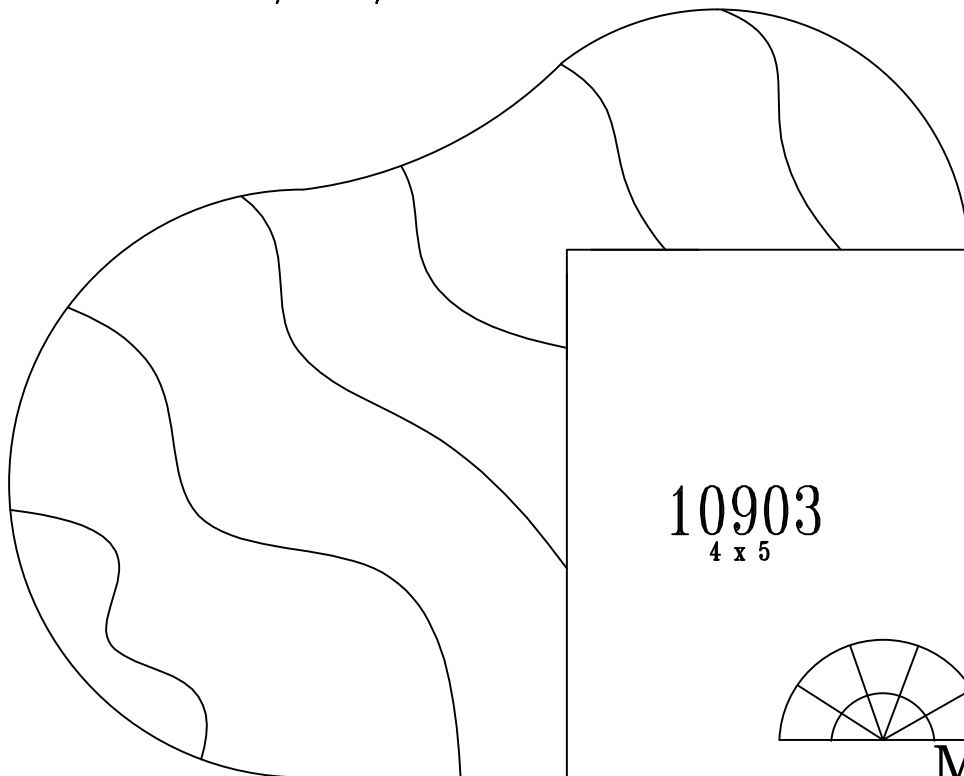

10903
4 x 5

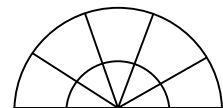

Fraser
Millworks

Bar Rail

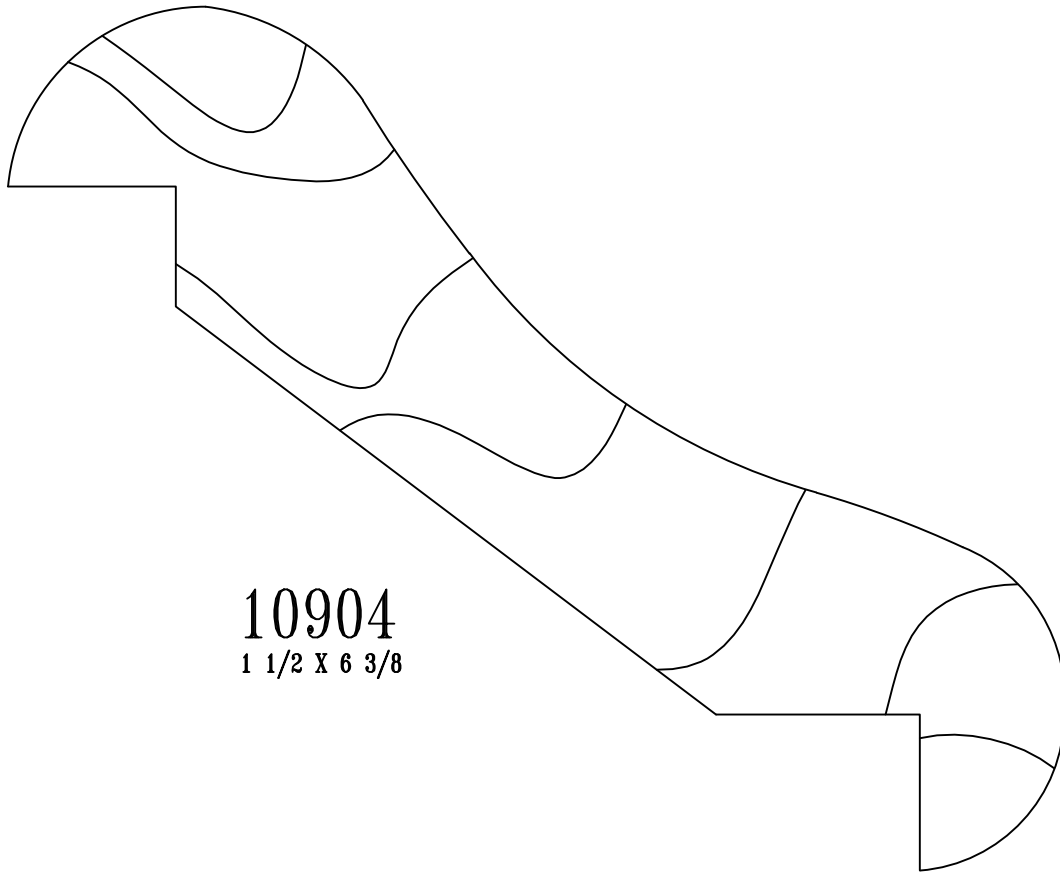

10904
1 1/2 X 6 3/8

Modillions

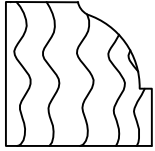

13001

$3/4 \times 3/4$

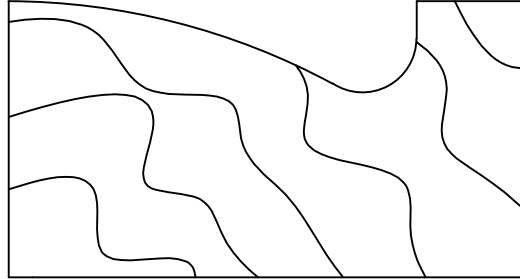

13004

$1 \frac{7}{16} \times 2 \frac{11}{16}$

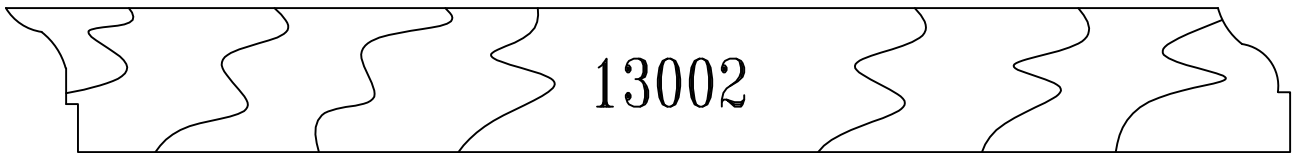

13002

$3/4 \times 6 \frac{3}{4}$

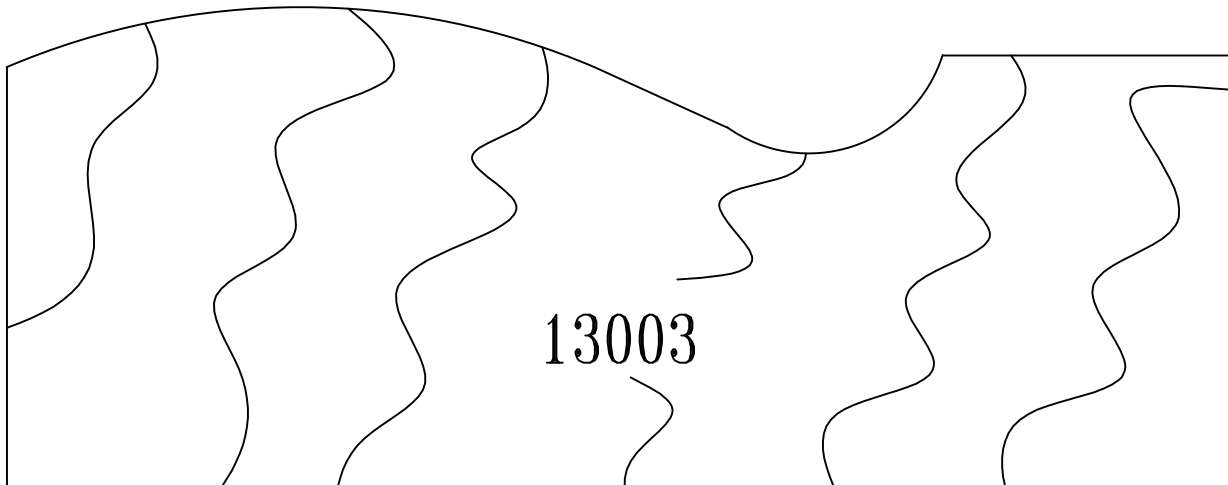

13003

$2 \frac{1}{2} \times 6 \frac{3}{8}$

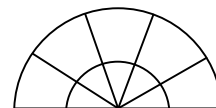

Fraser
Millworks

Modillions



13005

2 9/16 x 5 9/16

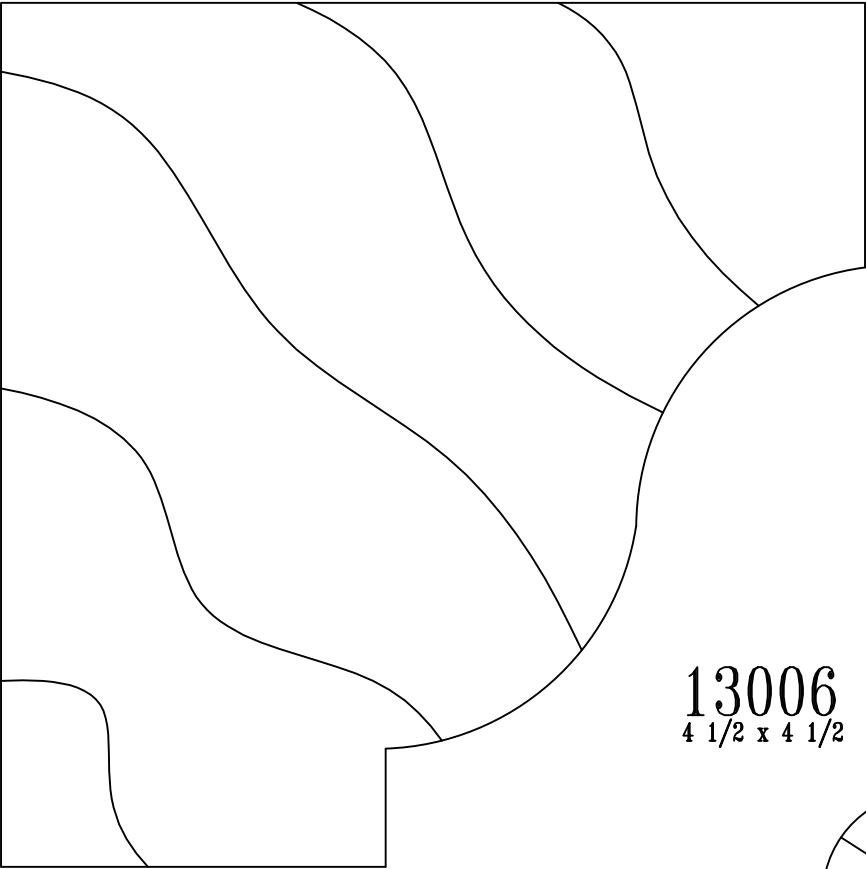

13006

4 1/2 x 4 1/2

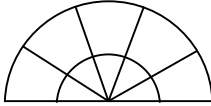

Fraser
Millworks

Modillions

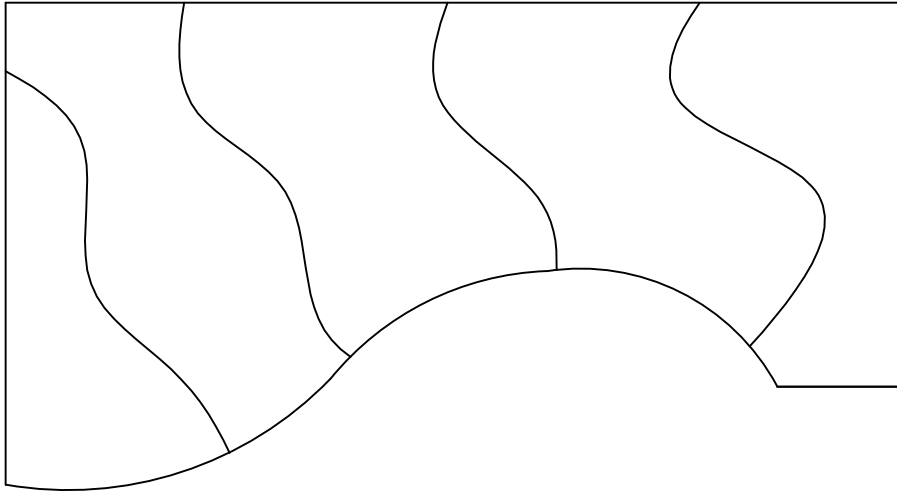

13007
2 1/2 x 4 11/16

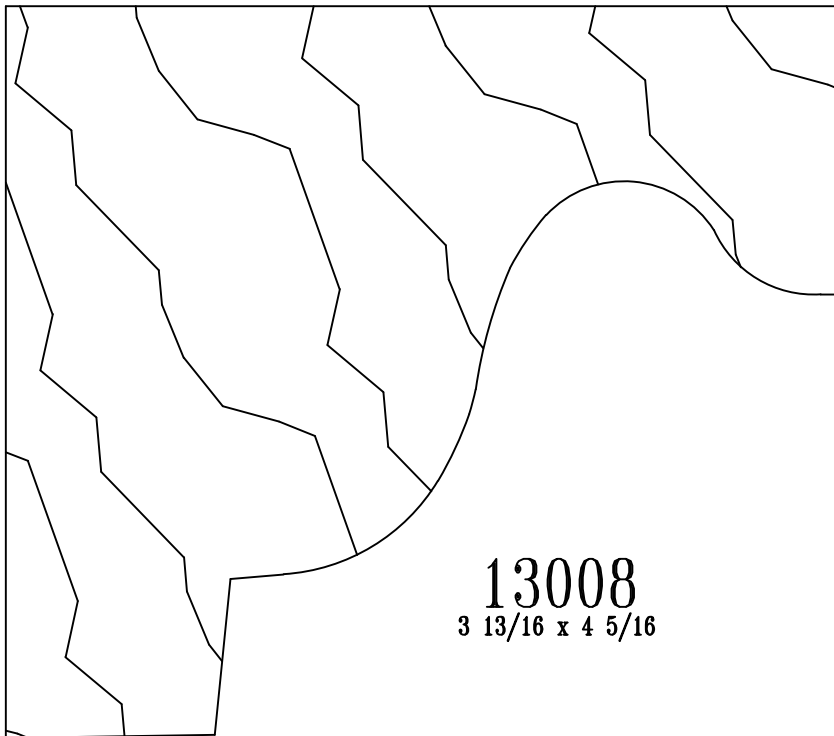

13008
3 13/16 x 4 5/16

Modillions

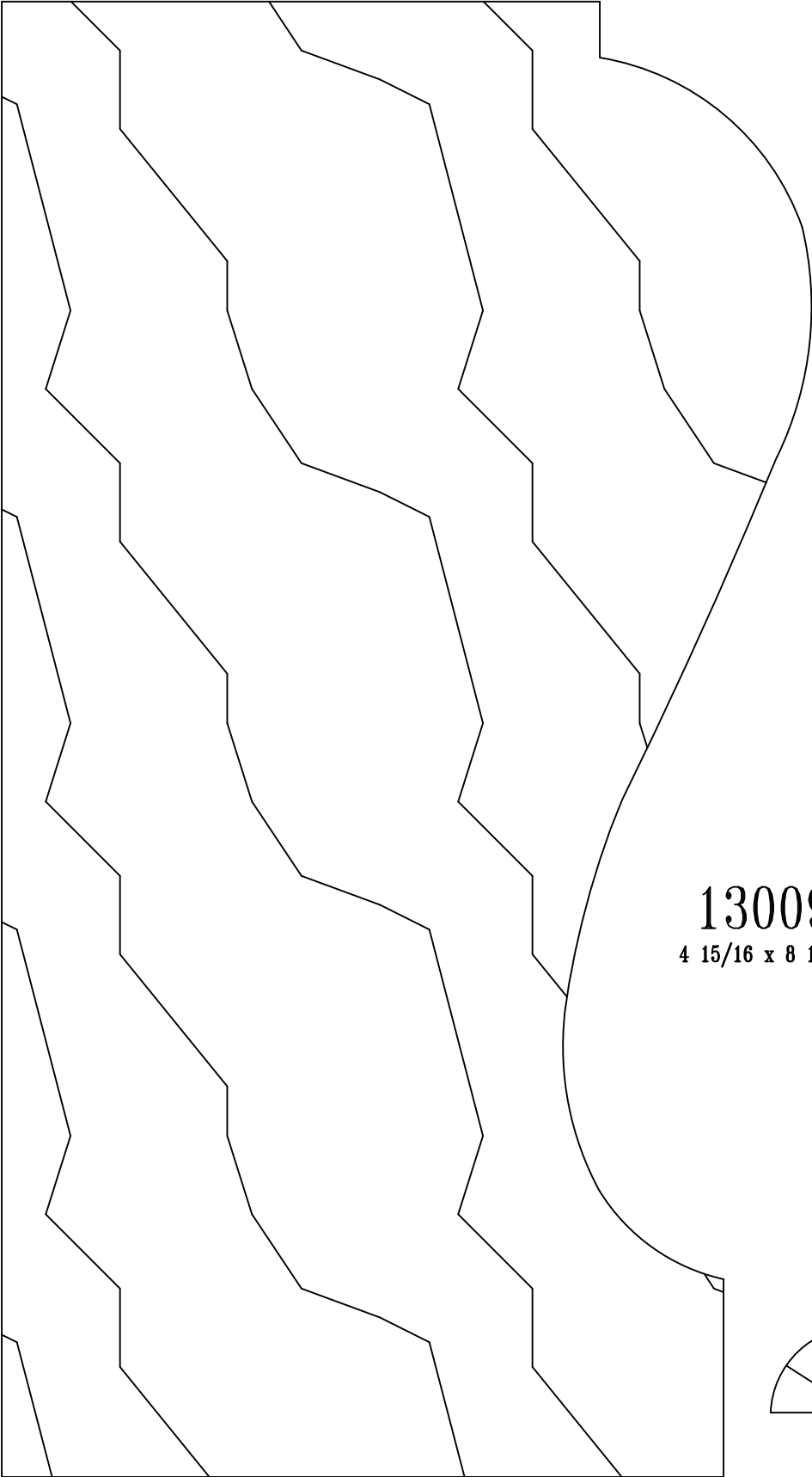

13009

4 15/16 x 8 15/16

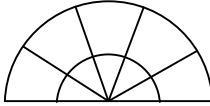

Fraser
Millworks

Mantel Surround

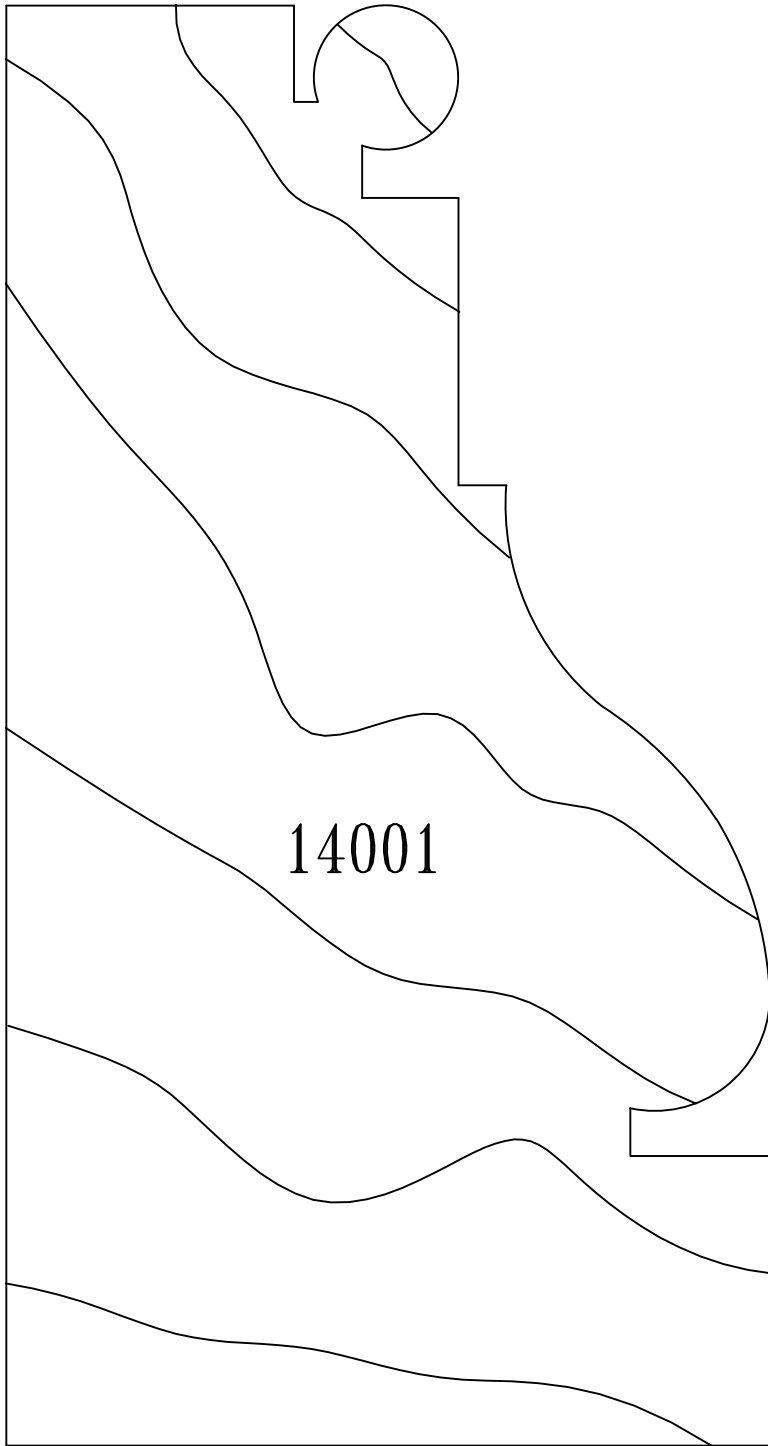

4 x 7 1/2

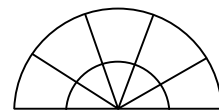

Fraser
Millworks

Mantel Surround

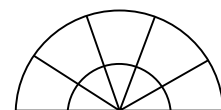
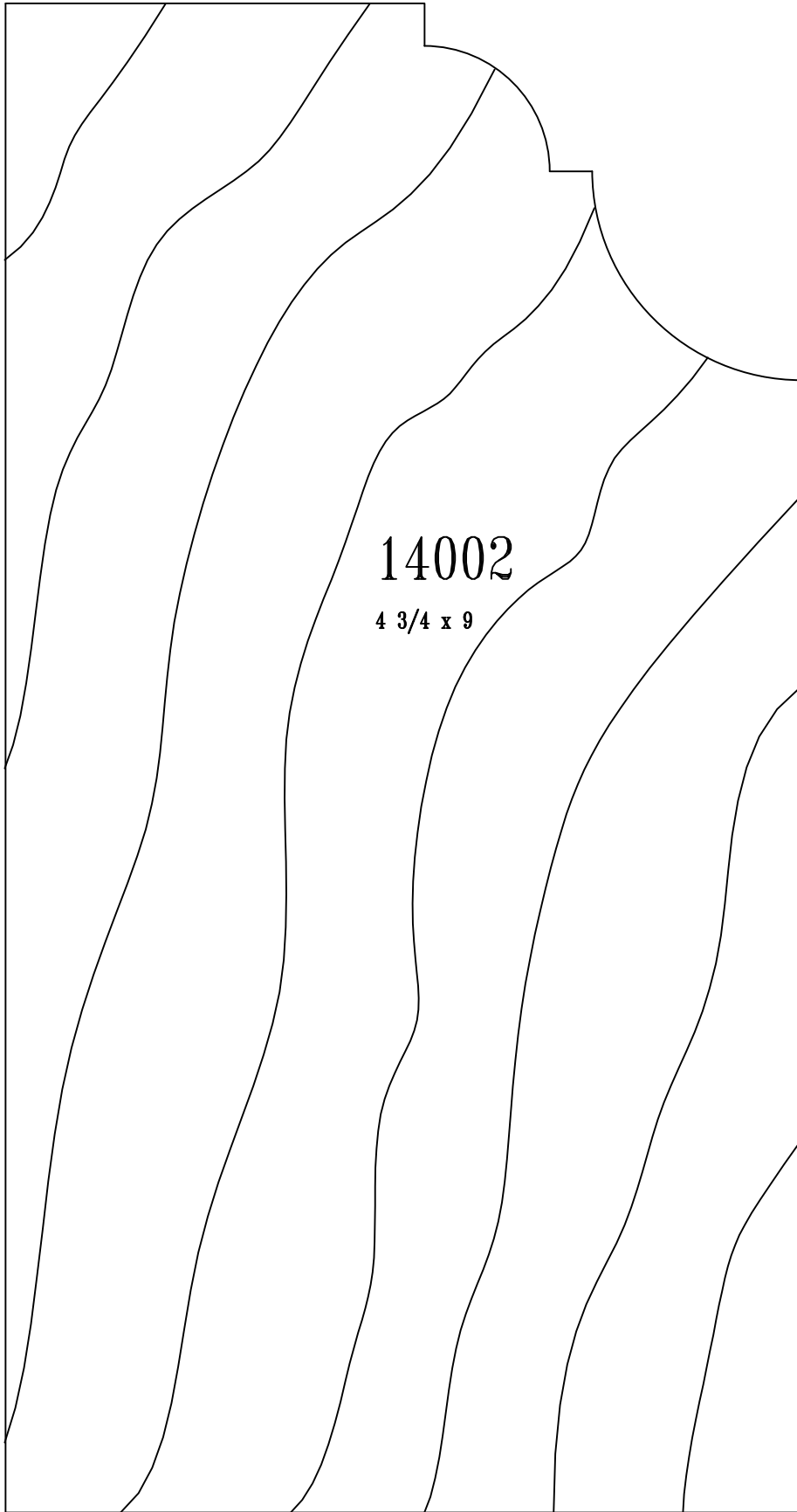

Fraser
Millworks

Miscellaneous

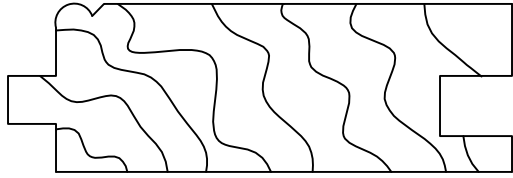

17002
7/8 x 2 5/8

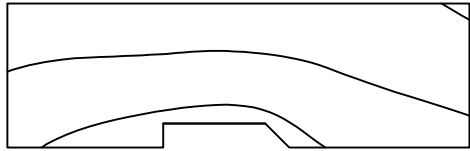

17003
3/4 x 2 1/2

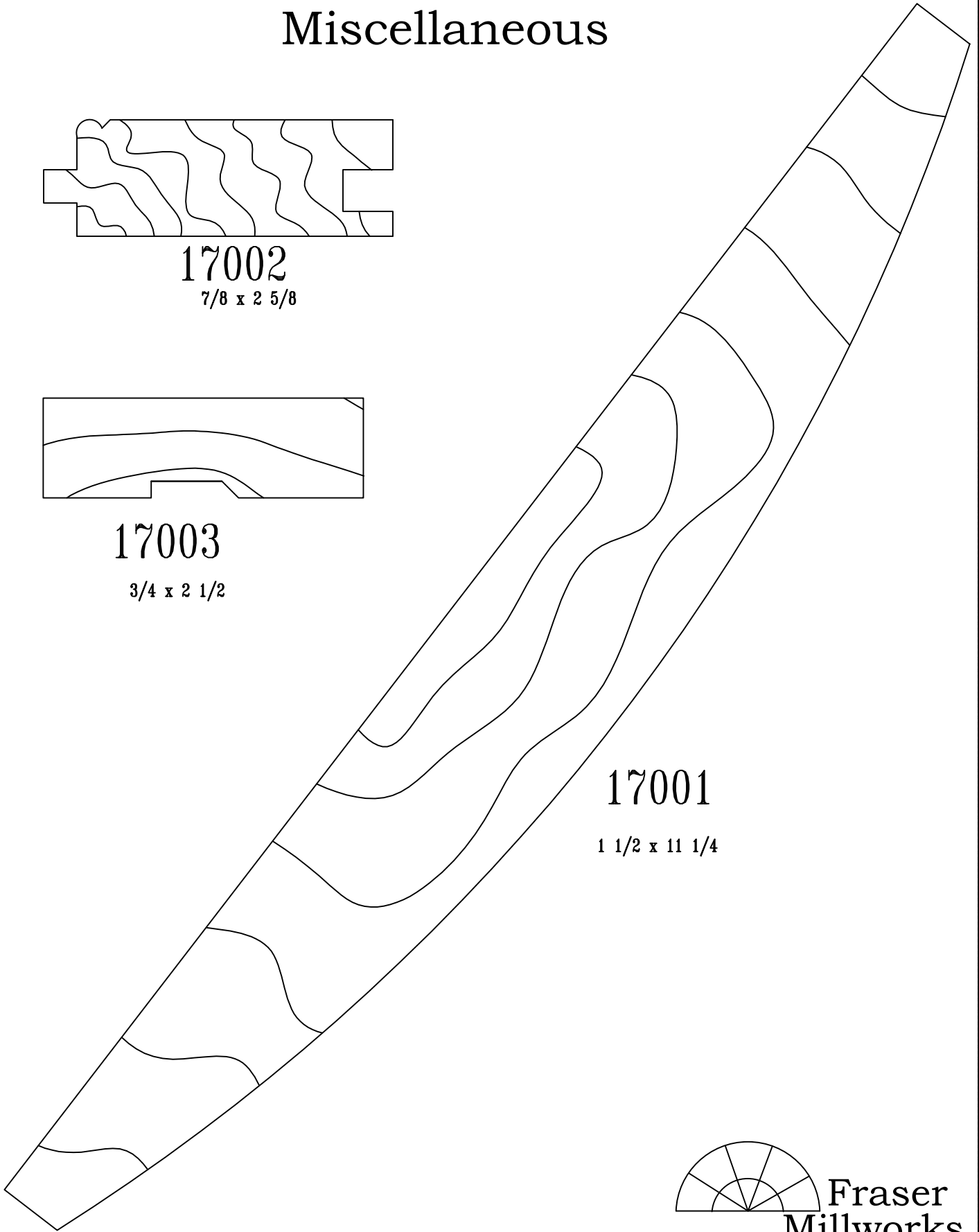

17001
1 1/2 x 11 1/4



Fraser
Millworks

Miscellaneous

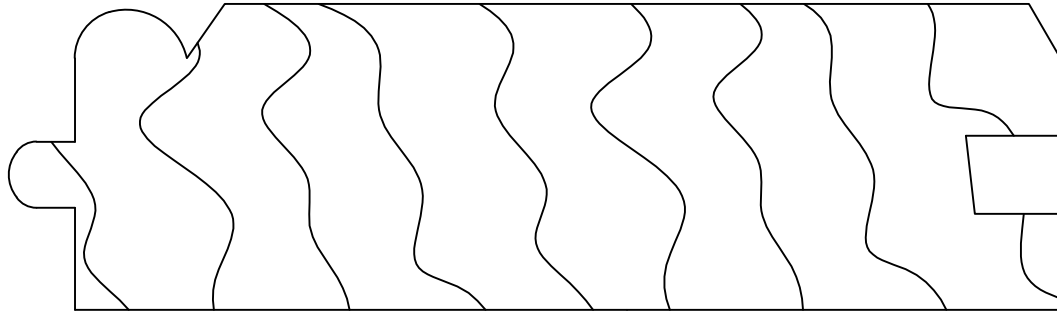

17004
 $1 \frac{5}{8} \times 5 \frac{1}{2}$

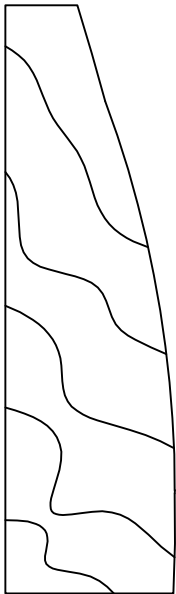

17005
 $\frac{7}{8} \times 3 \frac{1}{16}$



17006
 $\frac{3}{8} \times 5 \frac{1}{4}$

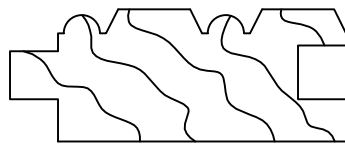

17007
 $\frac{11}{16} \times 1 \frac{3}{4}$

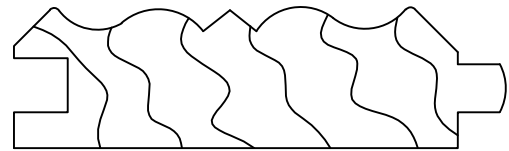

17008
 $\frac{3}{4} \times 2 \frac{9}{16}$

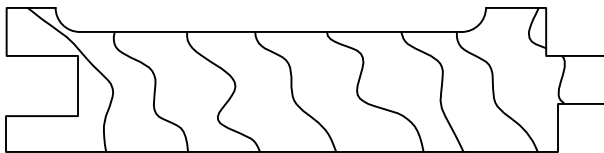

17009
 $\frac{3}{4} \times 3 \frac{1}{8}$

Miscellaneous

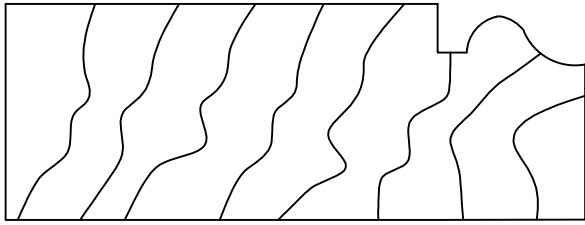

17011

1 1/8 x 3

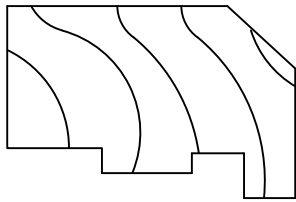

17013

1 x 1 1/2

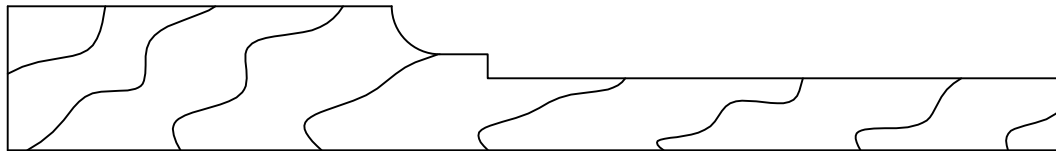

17014

3/4 x 5 1/2

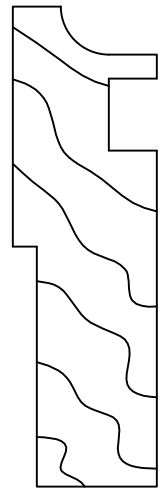

17015

3/4 x 2 1/2

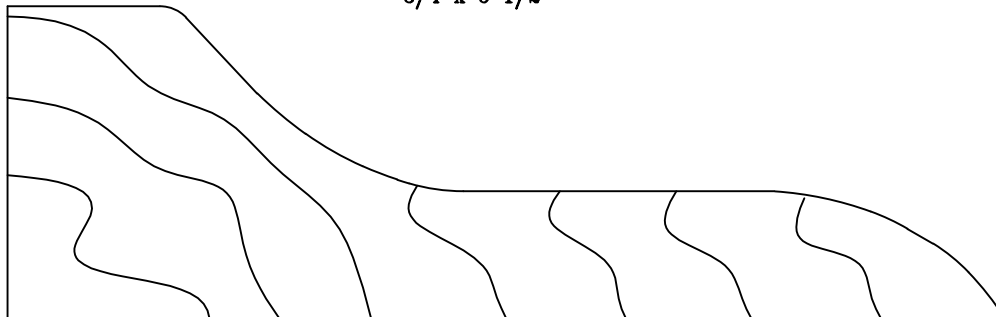

17016

1 5/8 x 5 3/16



Fraser
Millworks

Miscellaneous

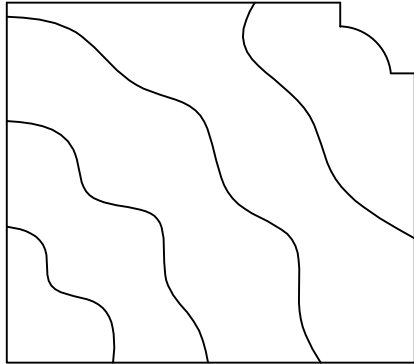

17018
1 7/8 x 2 1/8

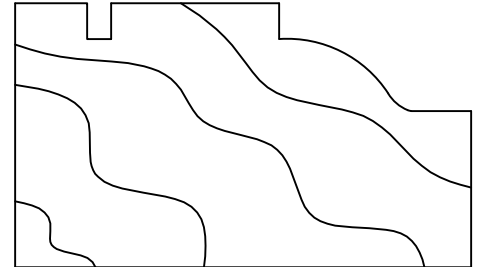

17022
1 3/8 x 2 3/8

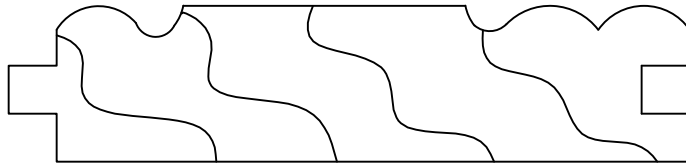

17017
1 1/8 x 10

17021
13/16 x 3 1/2

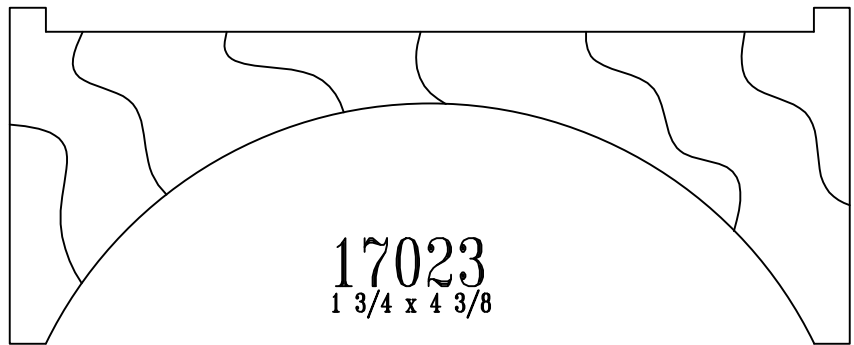

17023
1 3/4 x 4 3/8

Miscellaneous

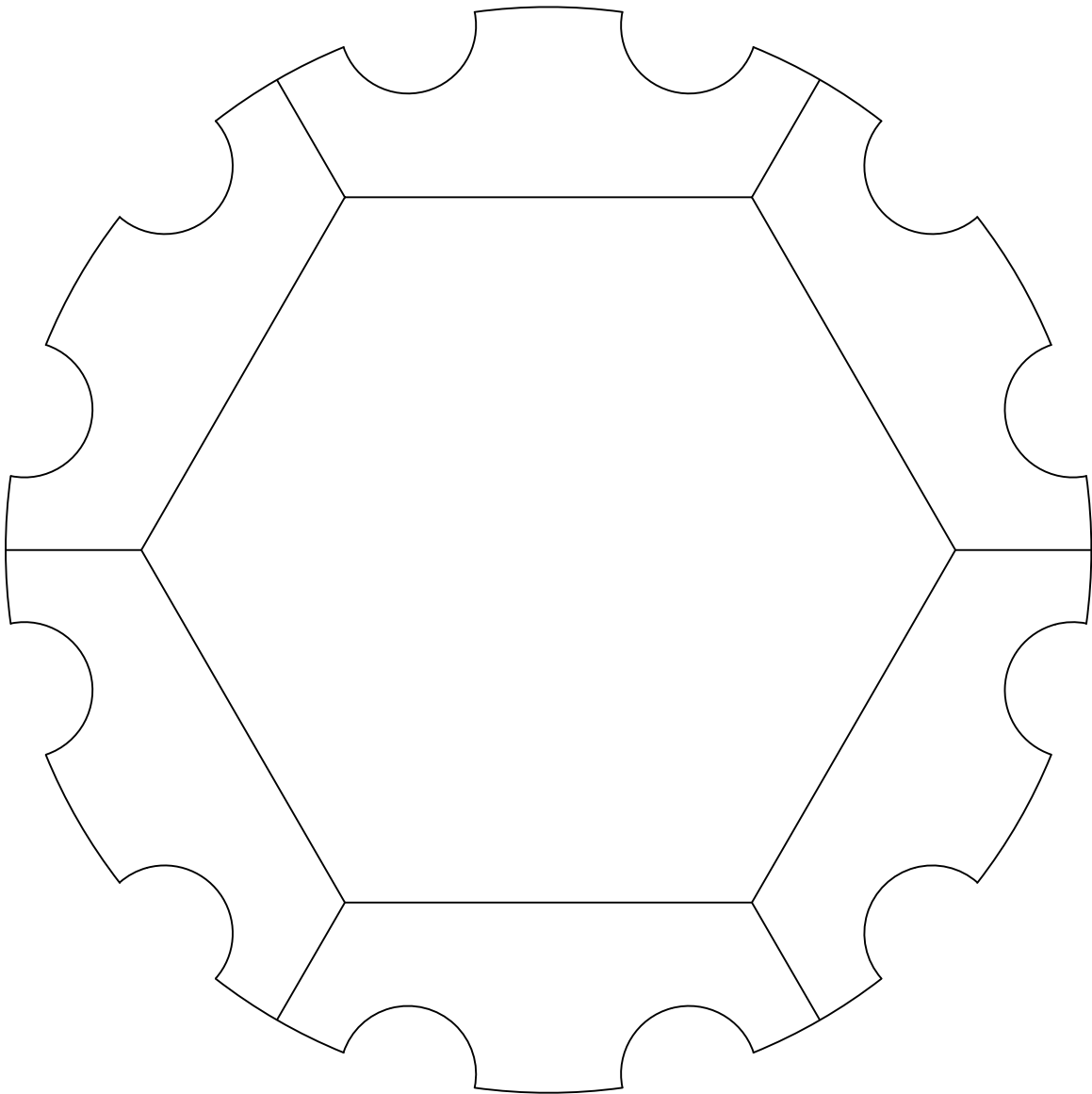
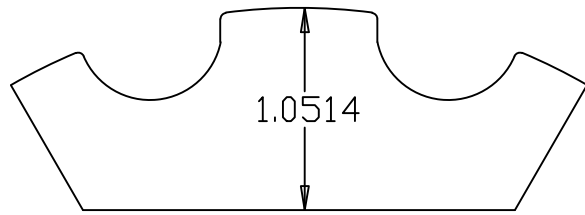
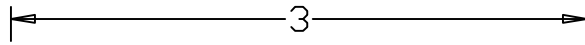

17024
6 x 6



Miscellaneous

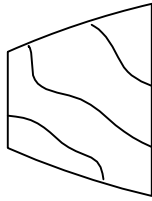

17025
 $\frac{3}{4} \times 1$

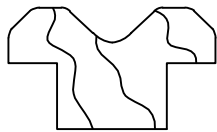

17027
 $\frac{5}{8} \times 1 \frac{1}{16}$

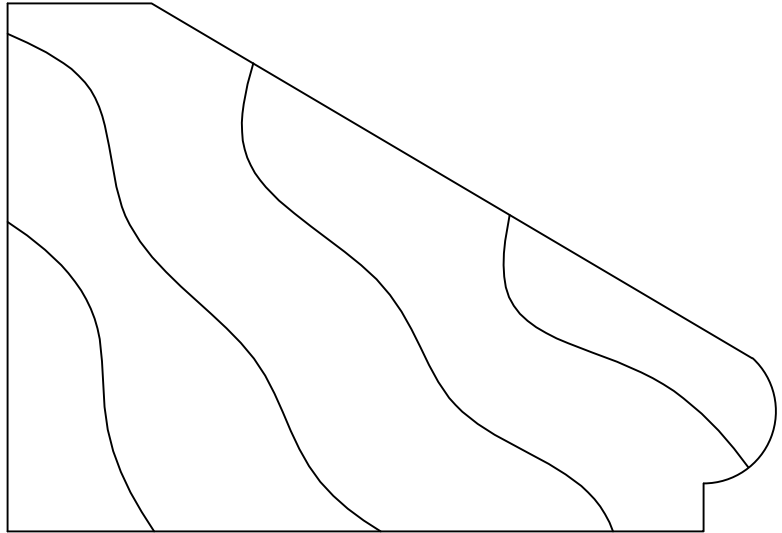

17026
 $2 \frac{3}{4} \times 4$

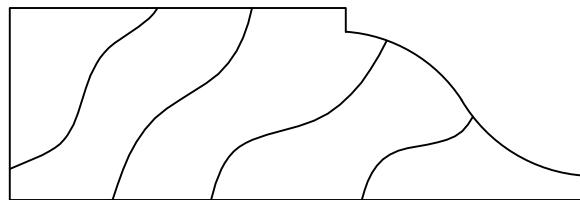

17028
 1×3

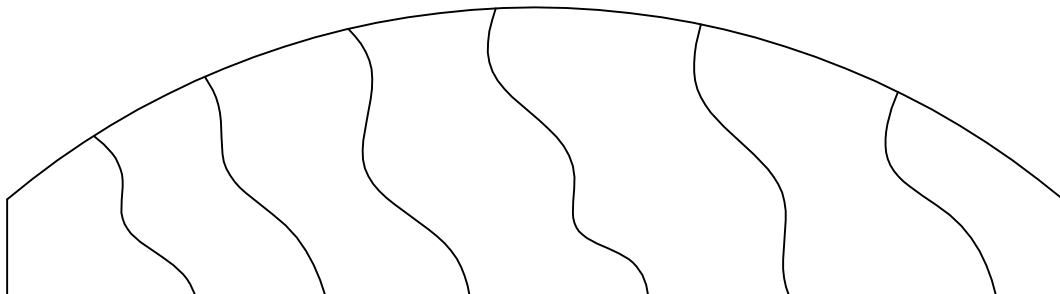

17029
 $1 \frac{1}{2} \times 5 \frac{1}{2}$



Fraser
Millworks

Miscellaneous

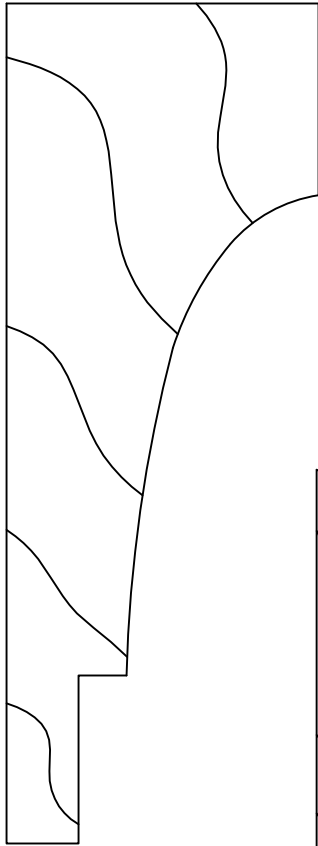

17030
1 5/8 x 4 3/8

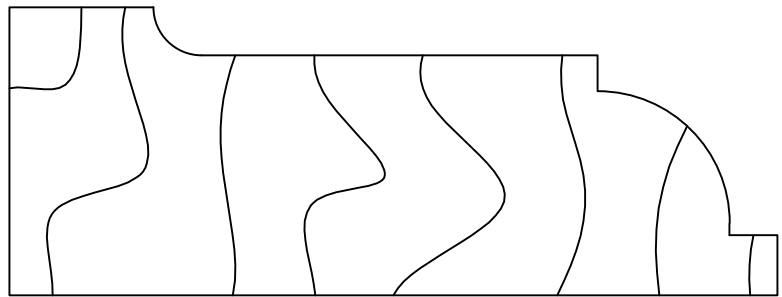

17031
1 1/2 x 4

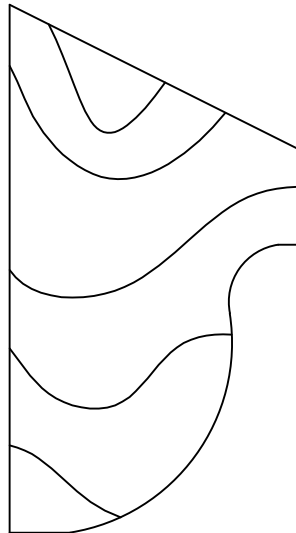

17032
1 1/2 x 2 3/4

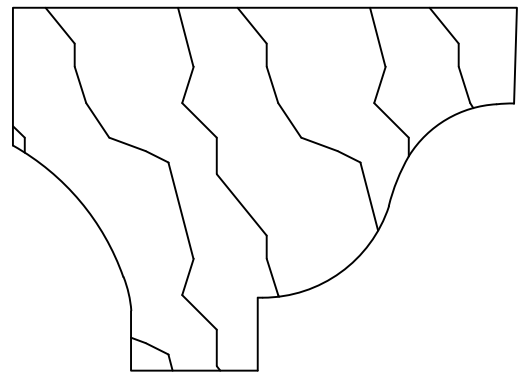

17033
1 7/8 x 2 5/8

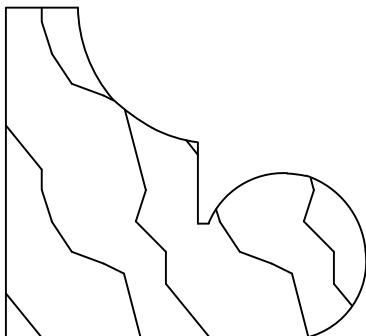

17034
1 3/4 x 1 7/8

Miscellaneous Sidings & Paneling

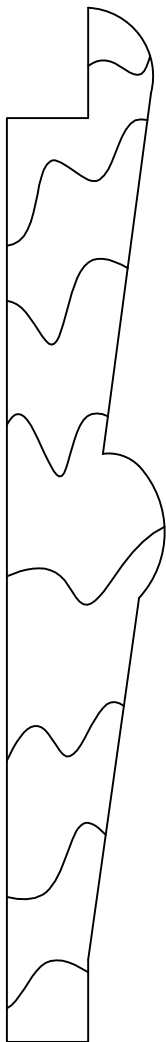

11001
13/16 x 5 1/2

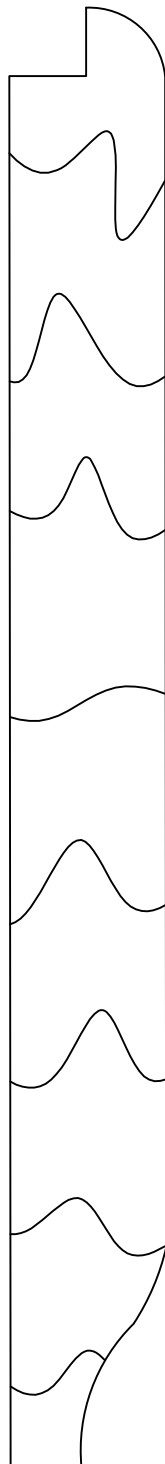

11002
3/4 x 7 5/8

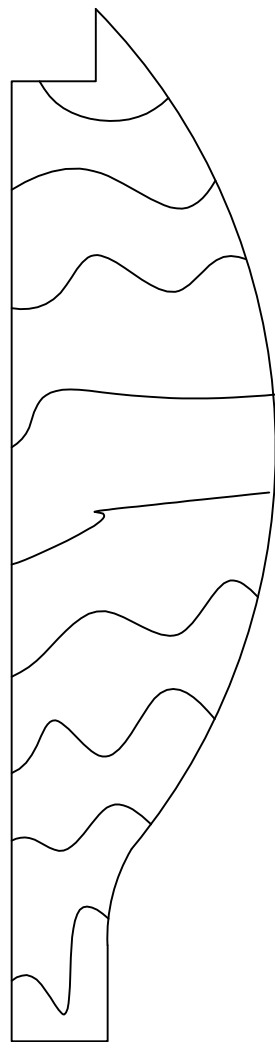

11003
1 3/8 x 5 5/16

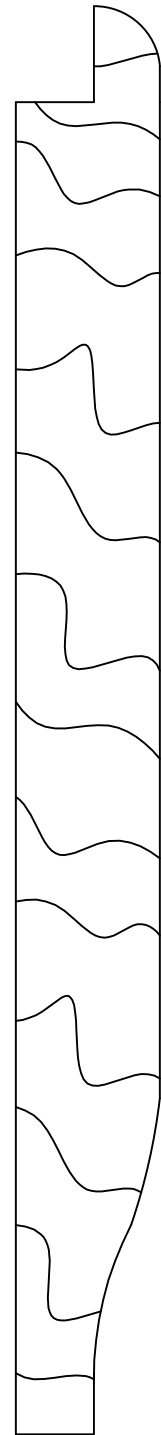

11004
3/4 x 7 7/16



Fraser
Millworks

Miscellaneous Sidings & Paneling

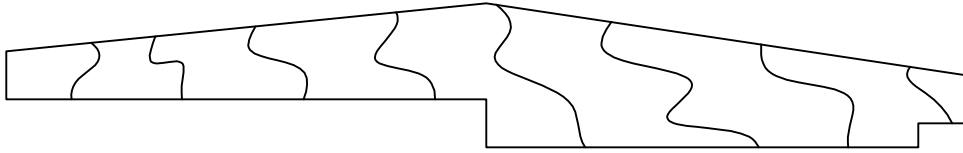

11005

$3/4 \times 5$

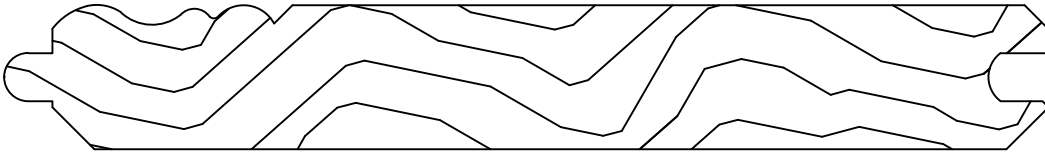

11006

$3/4 \times 5 \ 7/16$

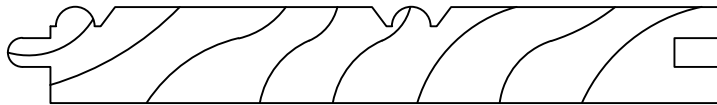

11007

$1/2 \times 3 \ 1/2$

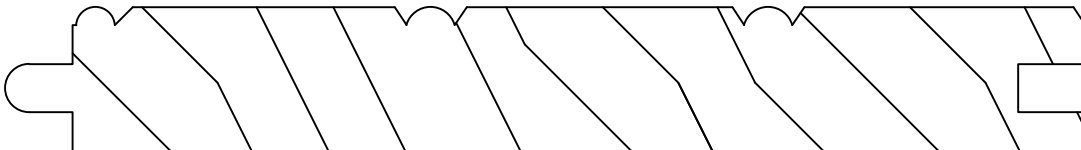

11008

$7/8 \times 4 \ 3/4$

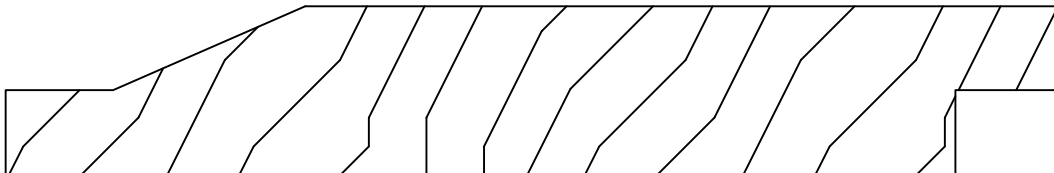

11009

$7/8 \times 5 \ 1/2$



Fraser
Millworks

Miscellaneous Sidings & Paneling

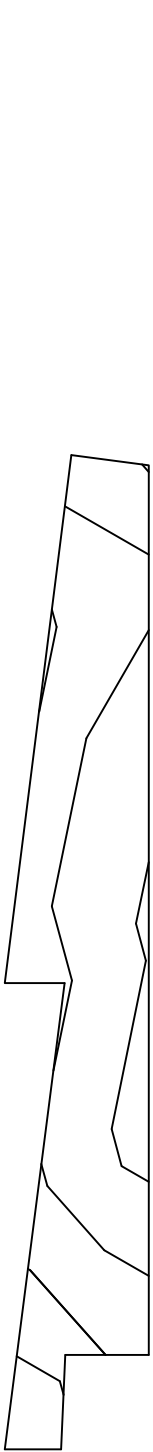

11010
3/4 x 5 3/16

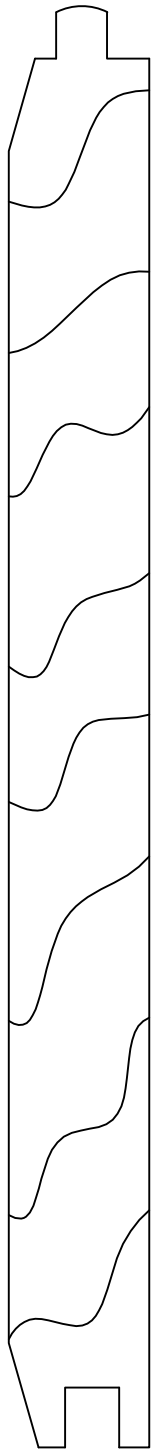

11011
3/4 x 7 1/2

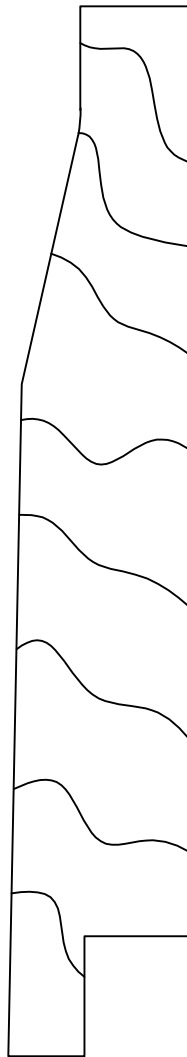

11012
15/16 x 5 1/2

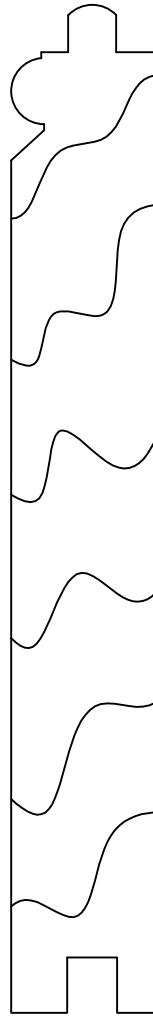

11013
3/4 x 5 1/4

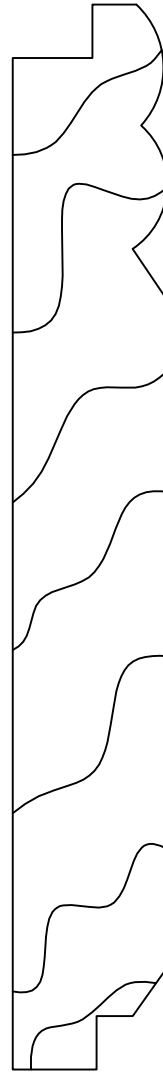

11014
13/16 x 5 1/2

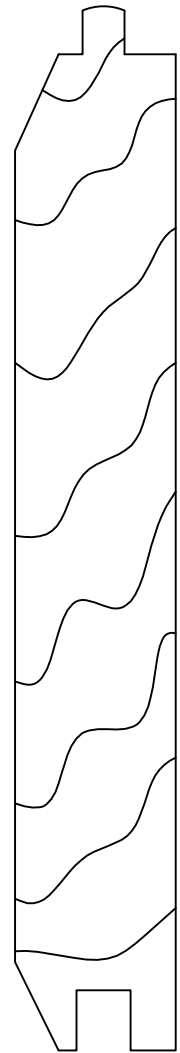

11015
13/16 x 5 1/2



**Fraser
Millworks**

Miscellaneous Sidings & Paneling

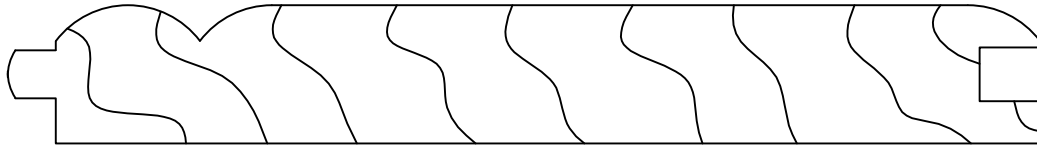

11016
 $\frac{3}{4} \times 5 \frac{3}{8}$

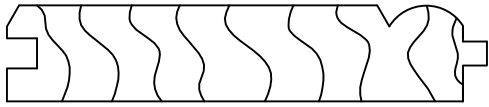

11017
 $\frac{1}{2} \times 2 \frac{1}{2}$

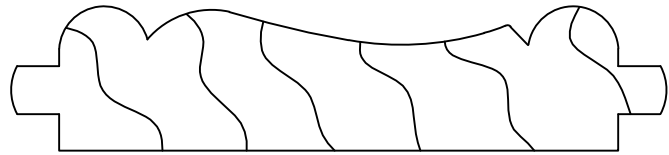

11018
 $\frac{3}{4} \times 3 \frac{7}{16}$

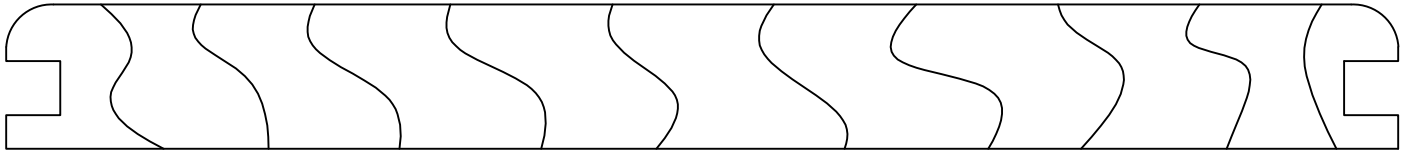

11019
 $\frac{3}{4} \times 7 \frac{1}{4}$

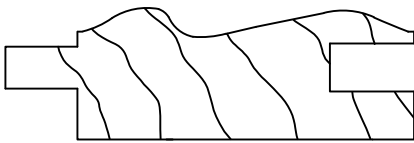

11020
 $\frac{11}{16} \times 2 \frac{1}{8}$

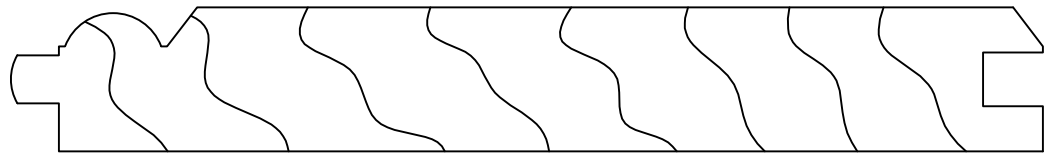

11021
 $\frac{3}{4} \times 5 \frac{3}{8}$

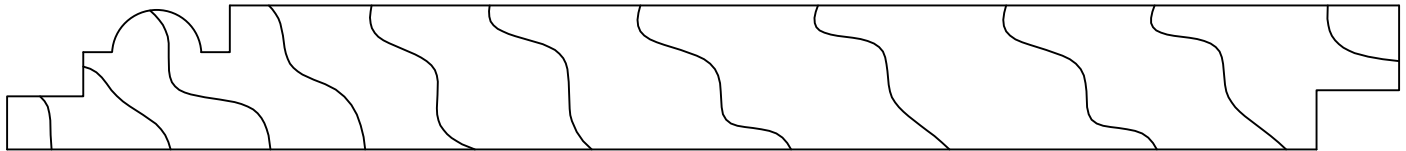

11022
 $\frac{3}{4} \times 7 \frac{1}{4}$

Miscellaneous Sidings & Paneling

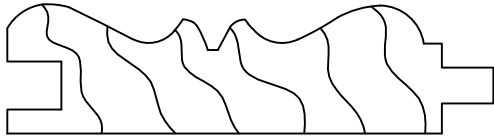

11023
11/16 x 2 1/2

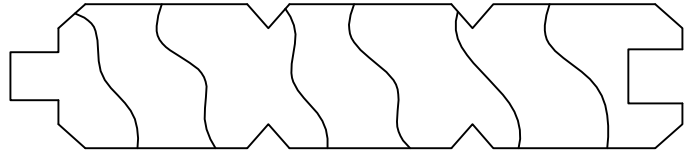

11024
3/4 x 3 1/2

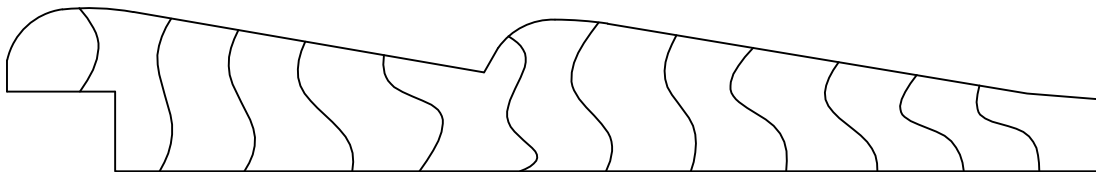

11025
7/8 x 5 11/16

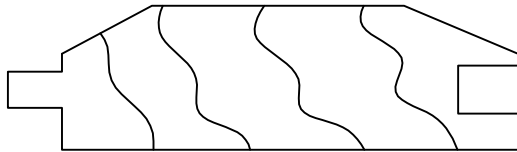

11026
3/4 x 2 5/8

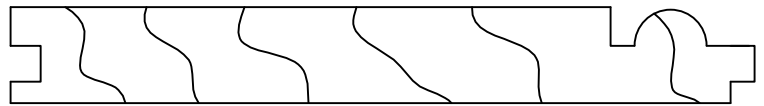

11027
1/2 x 3 7/8

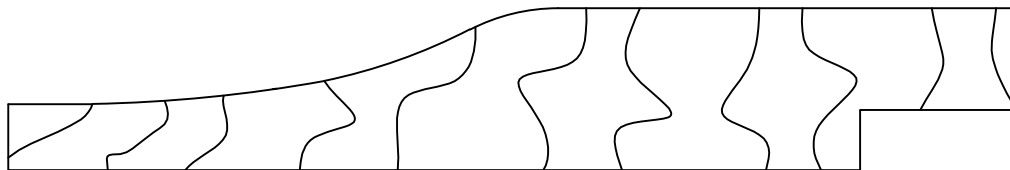

11028
27/32 X 5 1/4

Miscellaneous Sidings & Paneling

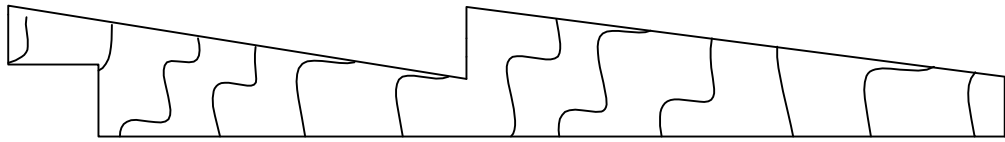

11029
3/4 x 5 1/8



11030
1/2 x 4 13/32

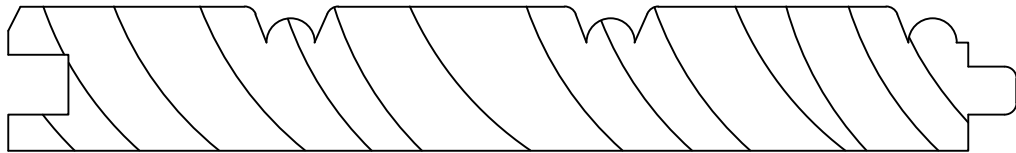

11031
3/4 x 5 1/4

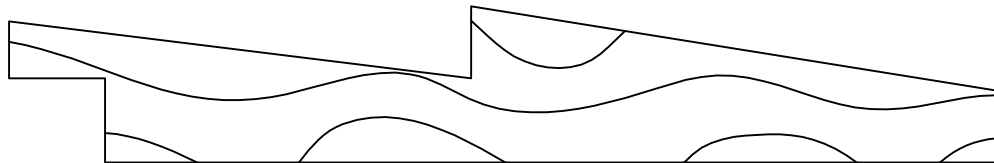

11032
13/16 x 5 1/8



11033
11/16 x 3 1/8 face



Miscellaneous Sidings & Paneling

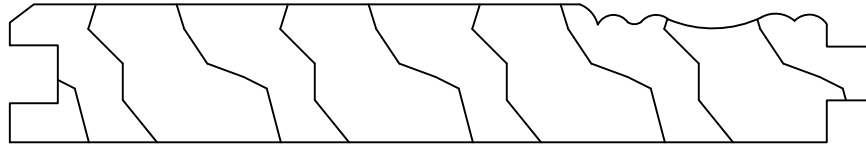

11034
 $3/4 \times 4 \ 7/16$

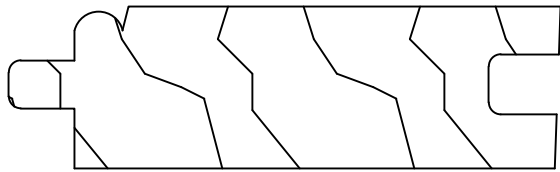

11035
 $13/16 \times 2 \ 7/8$

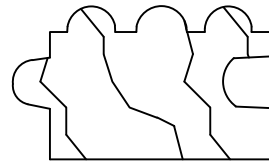

11036
 $3/4 \times 1 \ 3/8$