

Cove

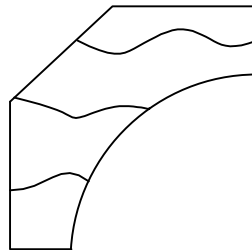

3/4 x 1 3/4

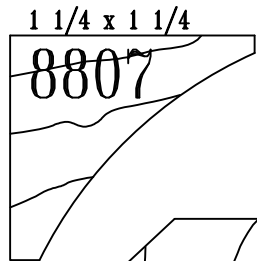
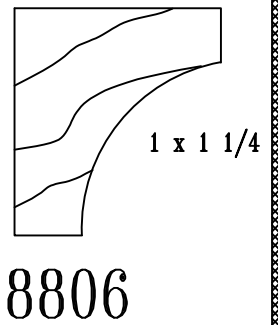
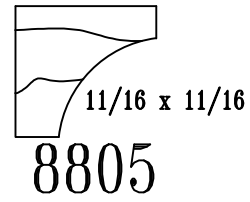
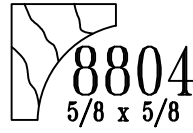
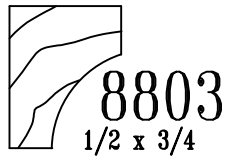
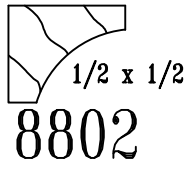
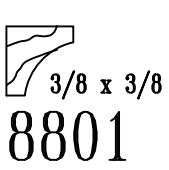
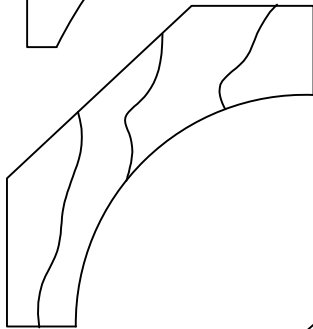

3/4 x 2 1/4

8814

1 5/8 x 6 15/16



3/4 x 4 1/4

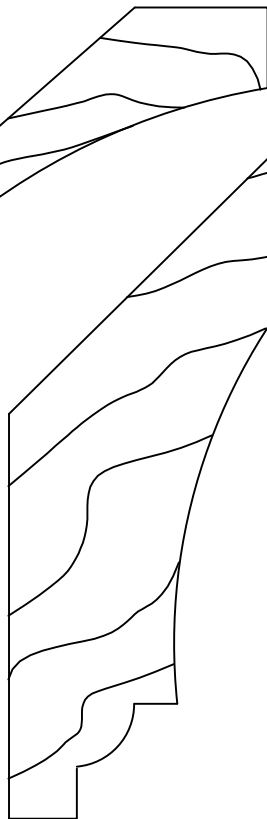

1 1/16 x 4 5/16

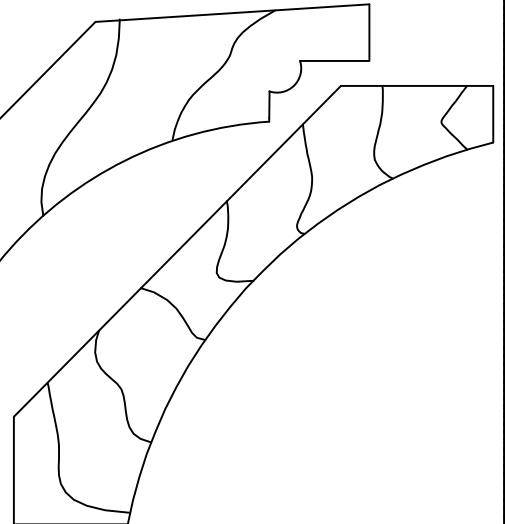

3/4 x 3 1/4

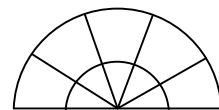

Fraser
Millworks

Cove

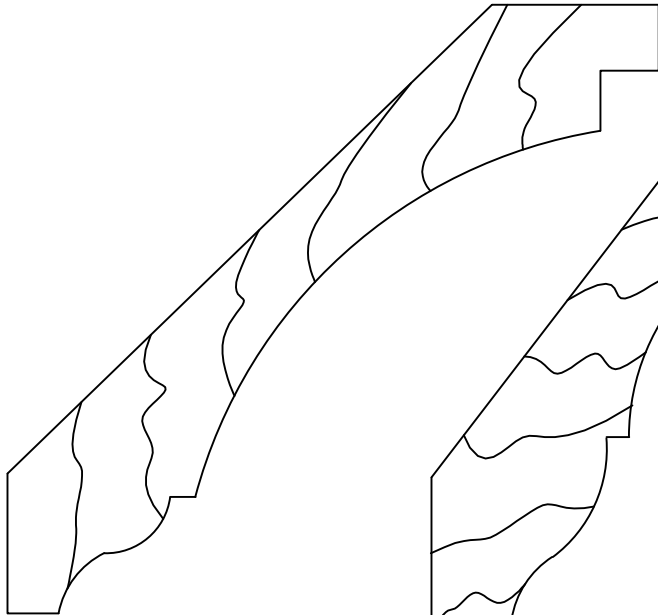

8815

$3/4 \times 4 \ 5/8$

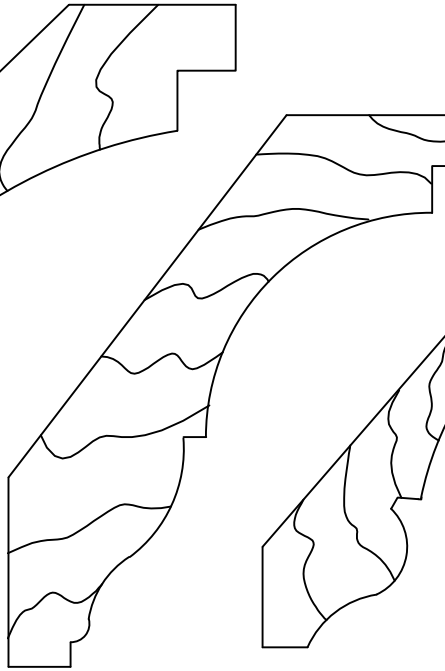

8816

$3/4 \times 3 \ 3/4$

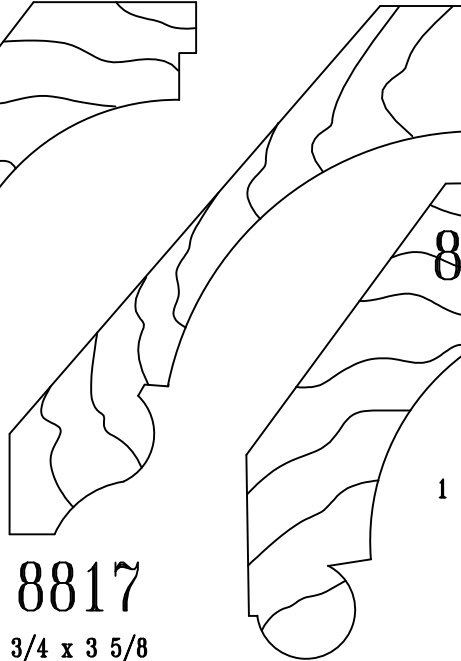

8817

$3/4 \times 3 \ 5/8$

8773

1 x 3

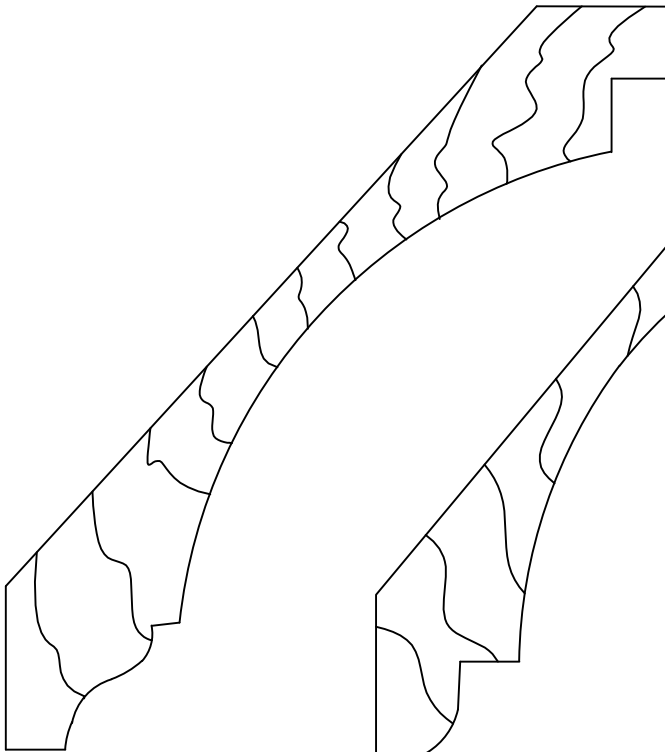

8818

$3/4 \times 5 \ 1/4$

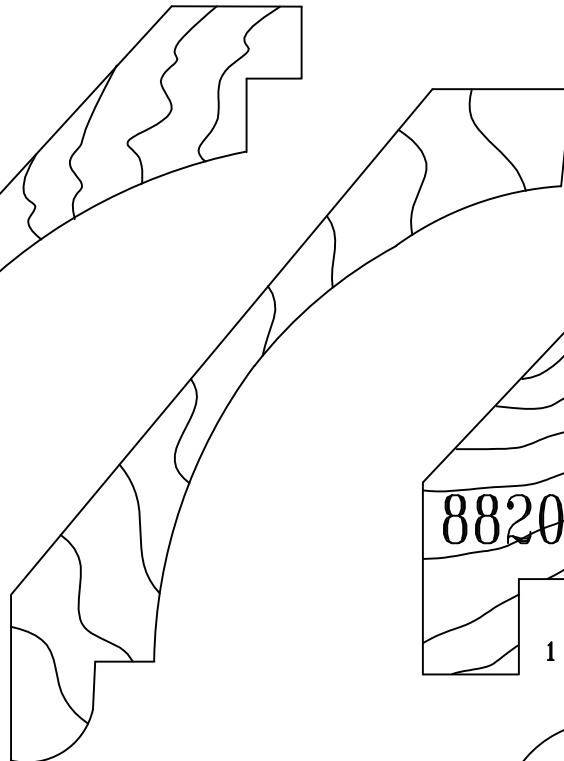

8819

$7/8 \times 4 \ 9/16$

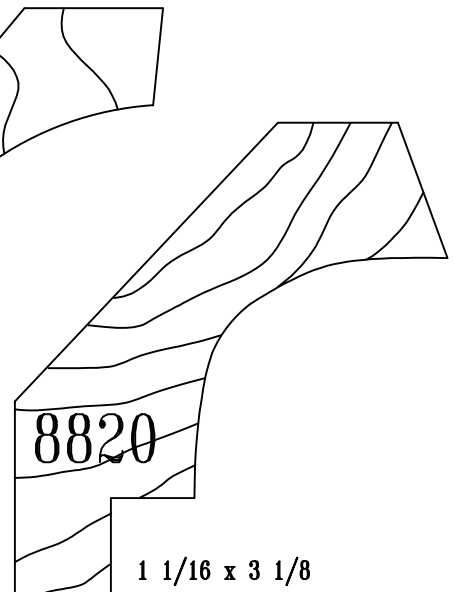

8820

$1 \ 1/16 \times 3 \ 1/8$

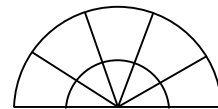

Fraser
Millworks

Cove

$1 \frac{5}{8} \times 2 \frac{1}{2}$

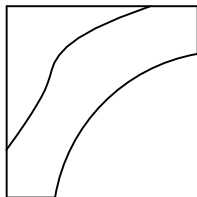
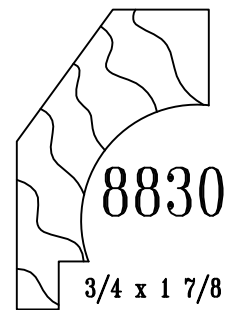
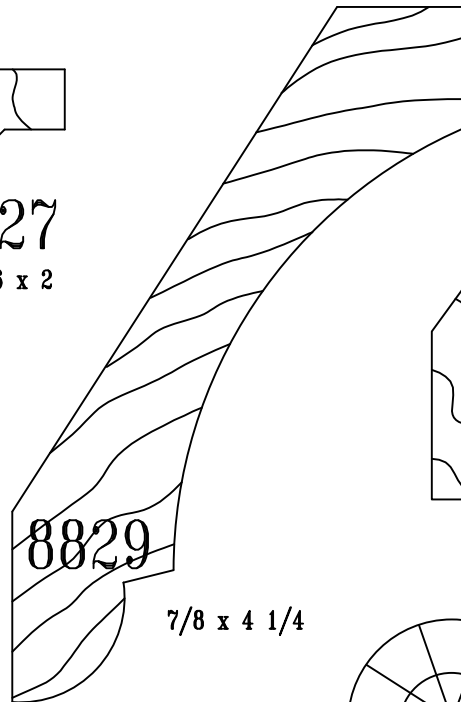
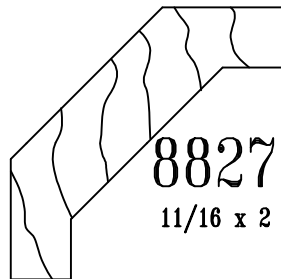
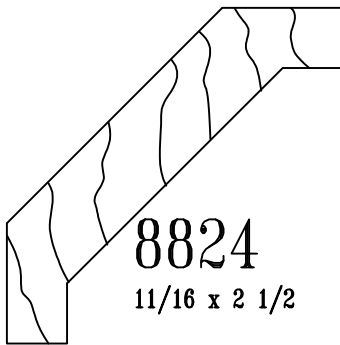
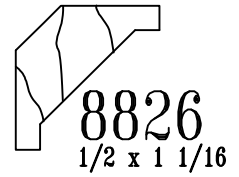
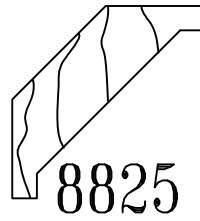
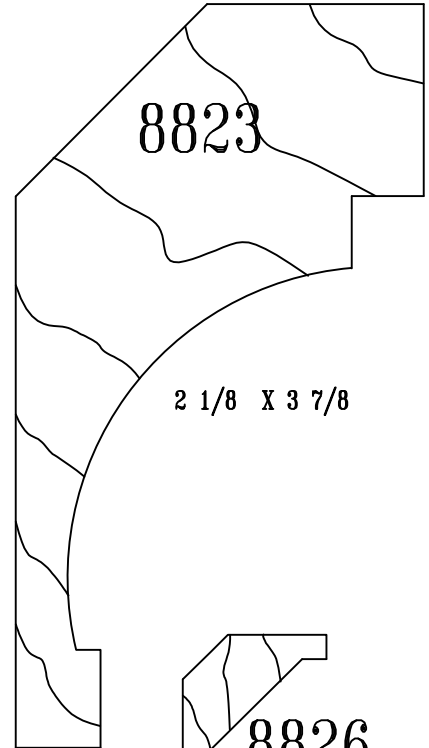
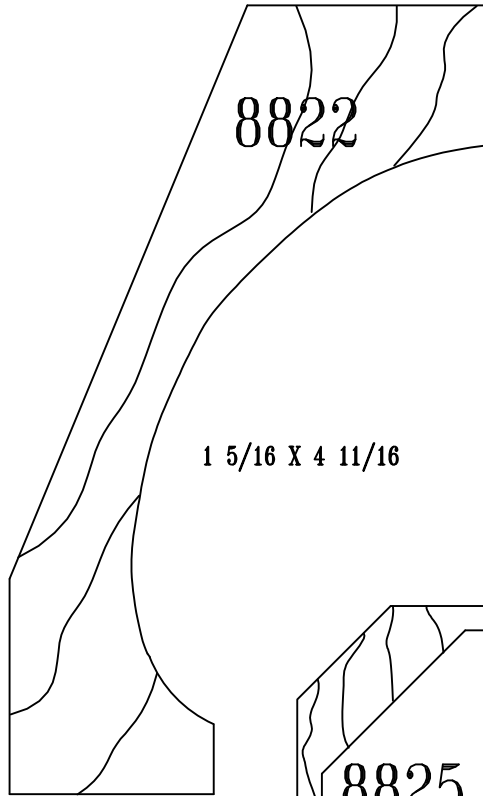
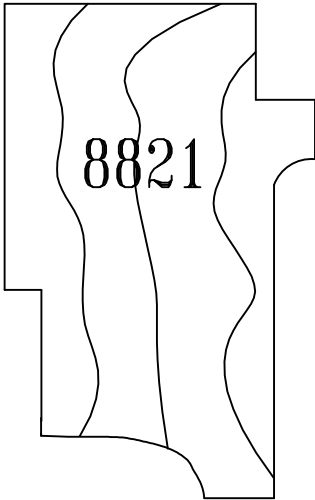

Fraser
Millworks

Cove

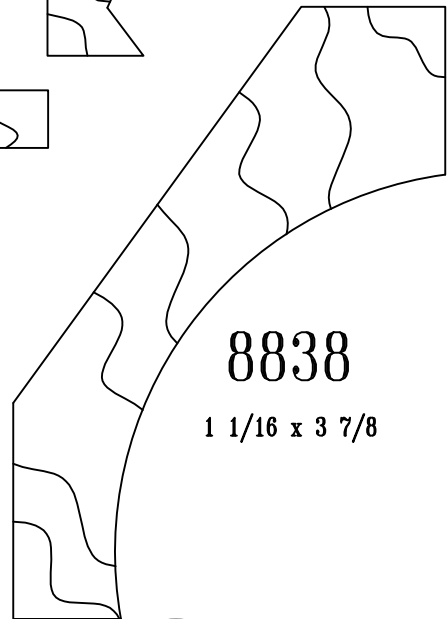
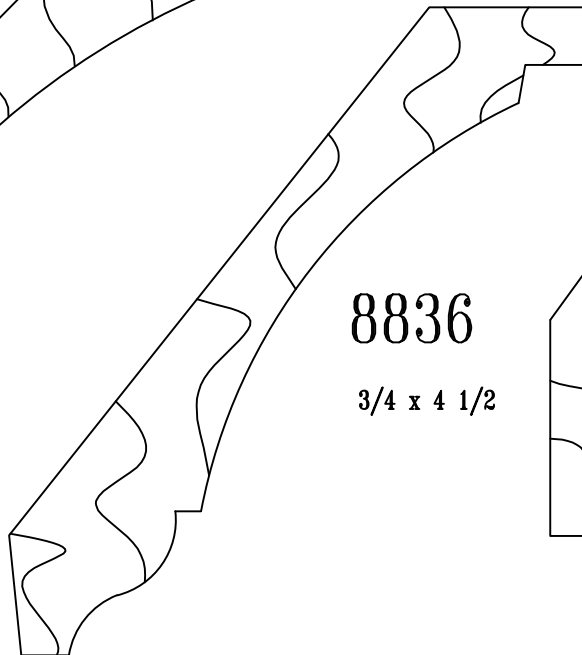
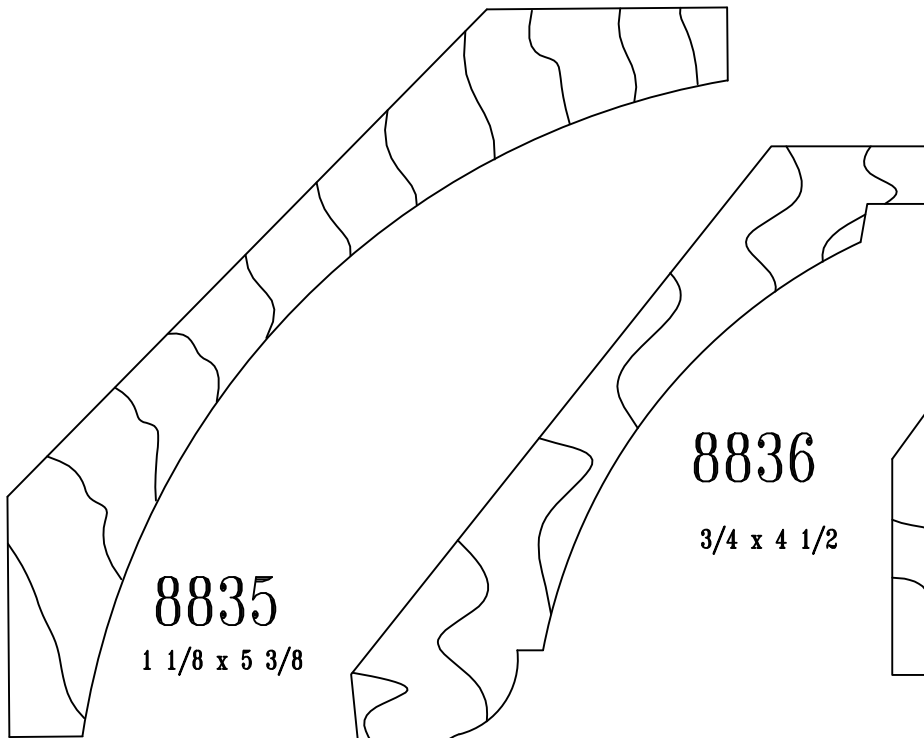
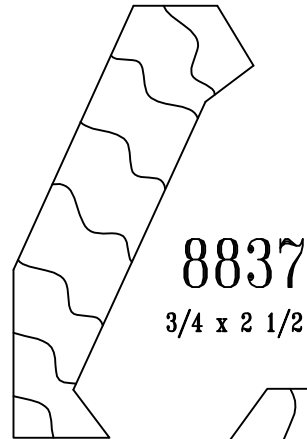
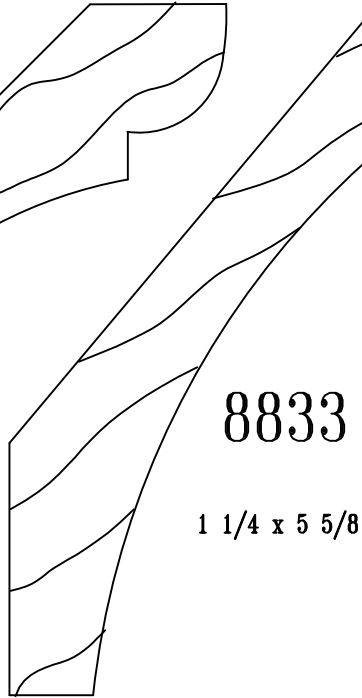
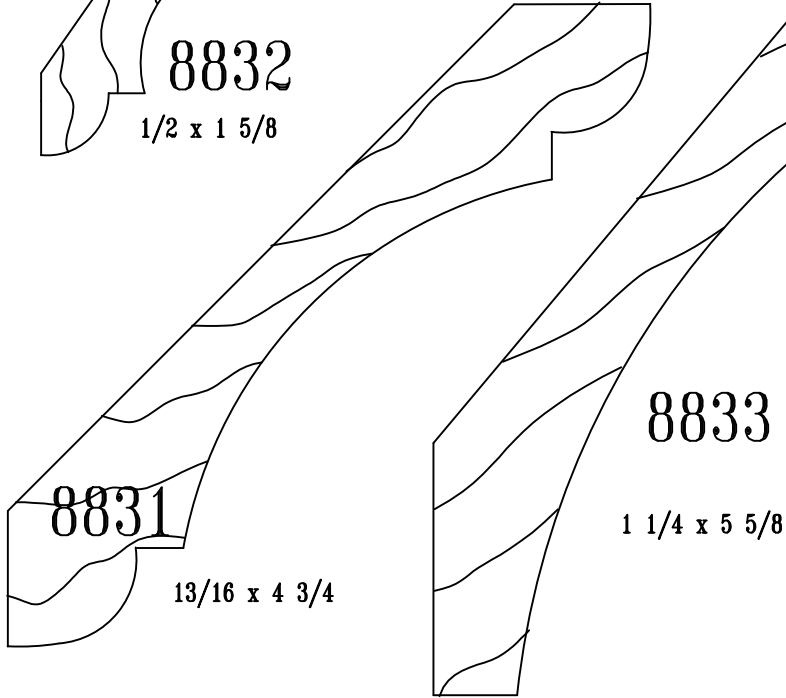
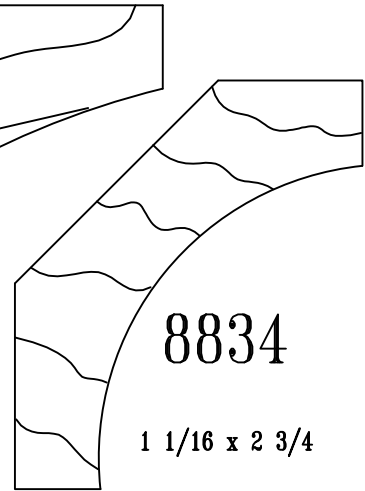
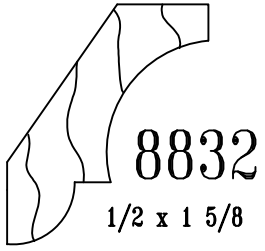

Cove

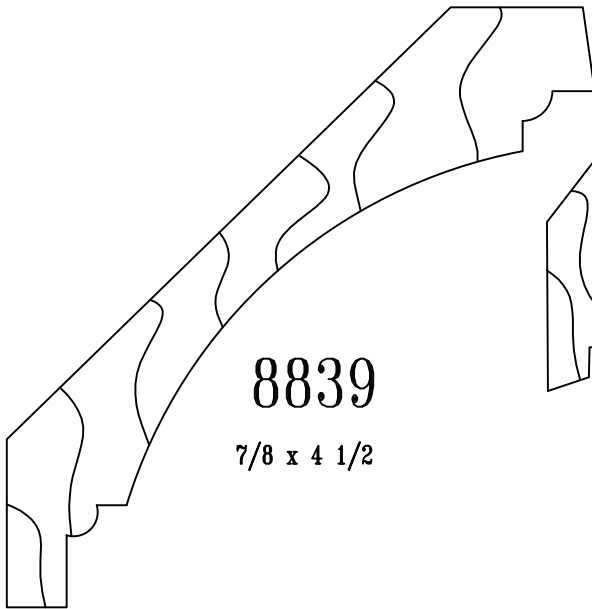

8839

$7/8 \times 4 \frac{1}{2}$

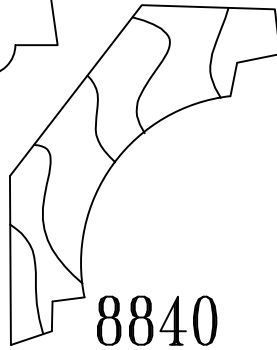

8840

$11/16 \times 2 \frac{3}{16}$

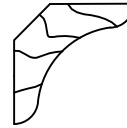

8841

$3/8 \times 15/16$

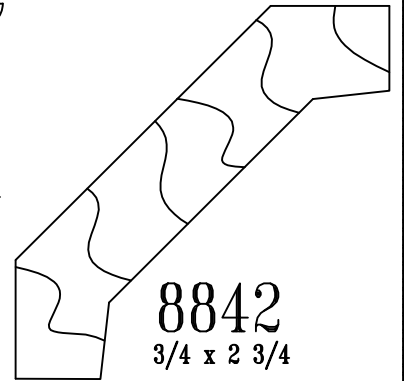

8842

$3/4 \times 2 \frac{3}{4}$

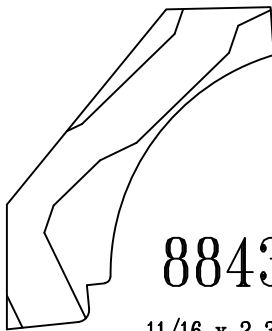

8843

$11/16 \times 2 \frac{3}{16}$

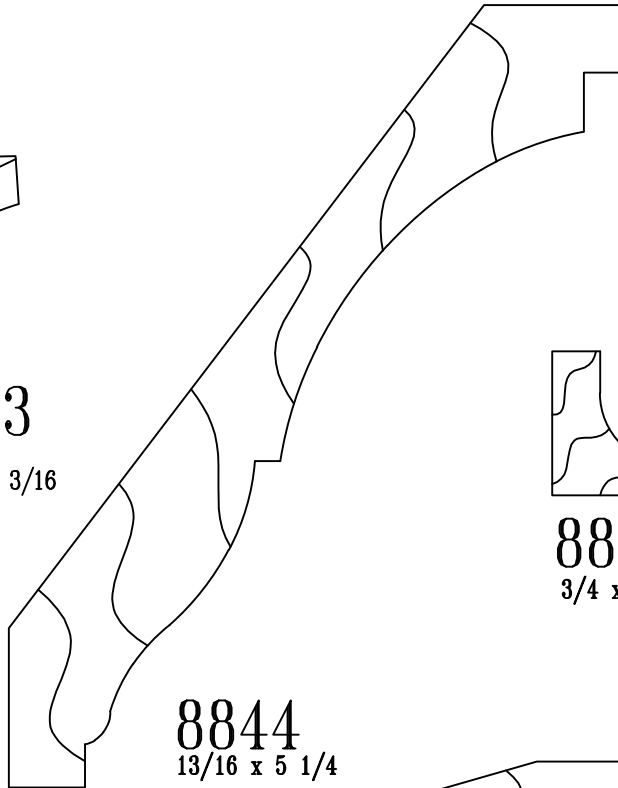

8844

$13/16 \times 5 \frac{1}{4}$

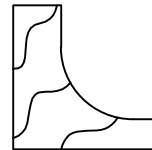

8845

$3/4 \times 3/4$

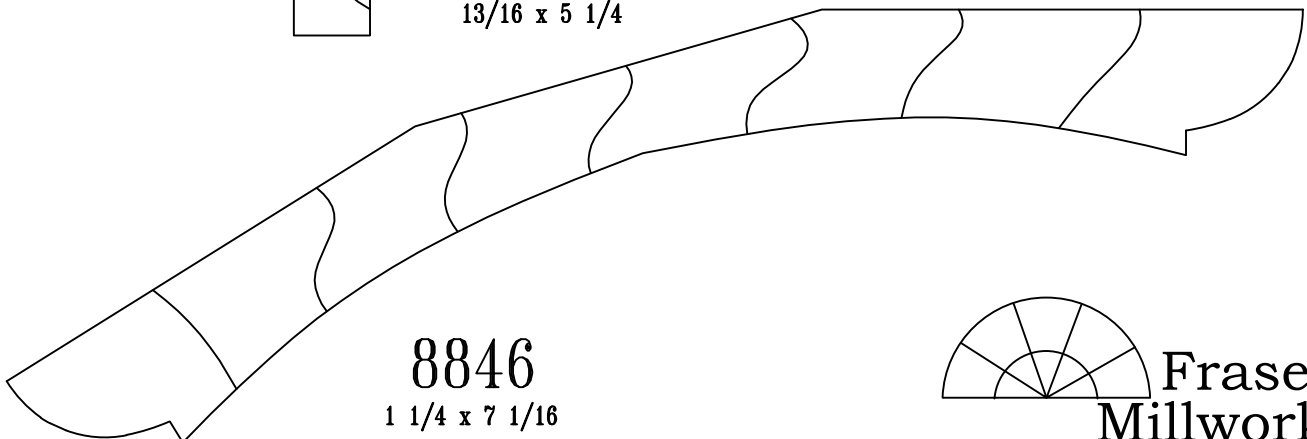

8846

$1 \frac{1}{4} \times 7 \frac{1}{16}$

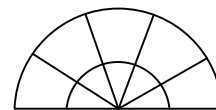

Fraser
Millworks

Cove

8847

$1 \frac{3}{8} \times 5 \frac{5}{8}$

8848

$1 \frac{1}{2} \times 5 \frac{1}{2}$

8849

$1 \frac{1}{8} \times 7 \frac{3}{8}$

8850

$\frac{3}{4} \times 3 \frac{11}{16}$

8851

$1 \frac{1}{2} \times 4 \frac{5}{8}$



Fraser
Millworks

Cove

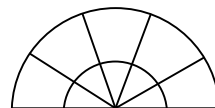
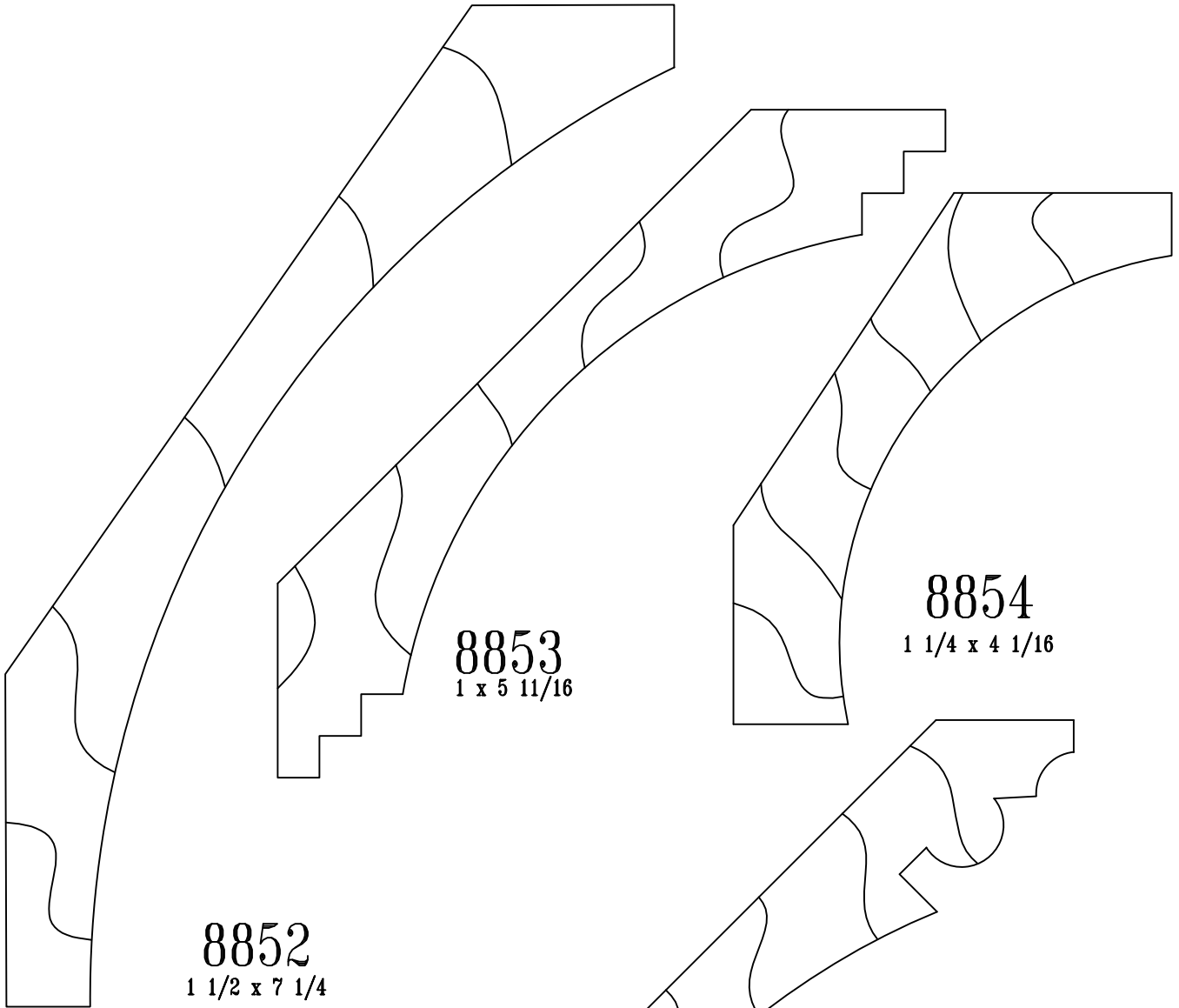

Fraser
Millworks

Cove

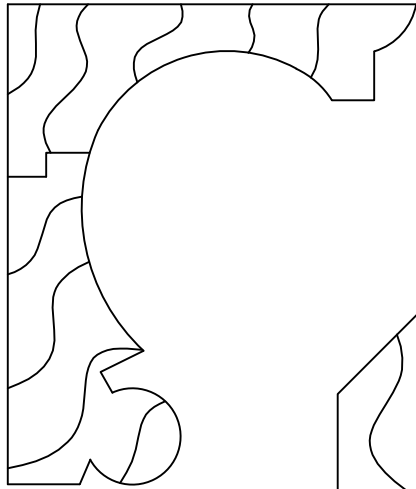

8856
2 1/8 x 2 1/2

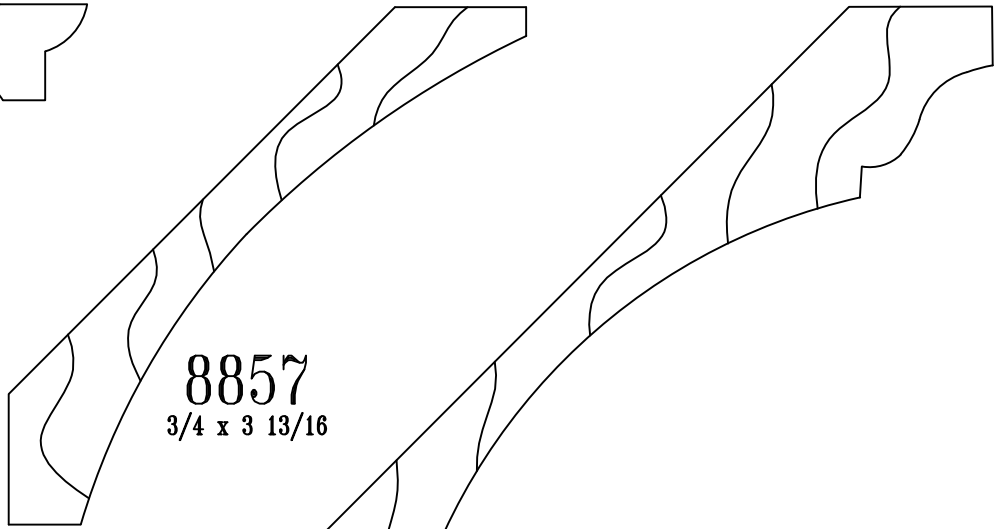

8857
3/4 x 3 13/16



8858
3/4 x 5 3/4

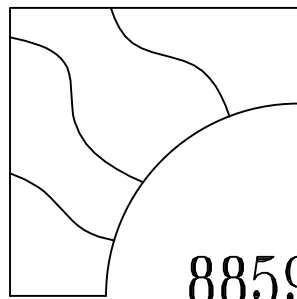

8859
1 1/2 x 1 1/2

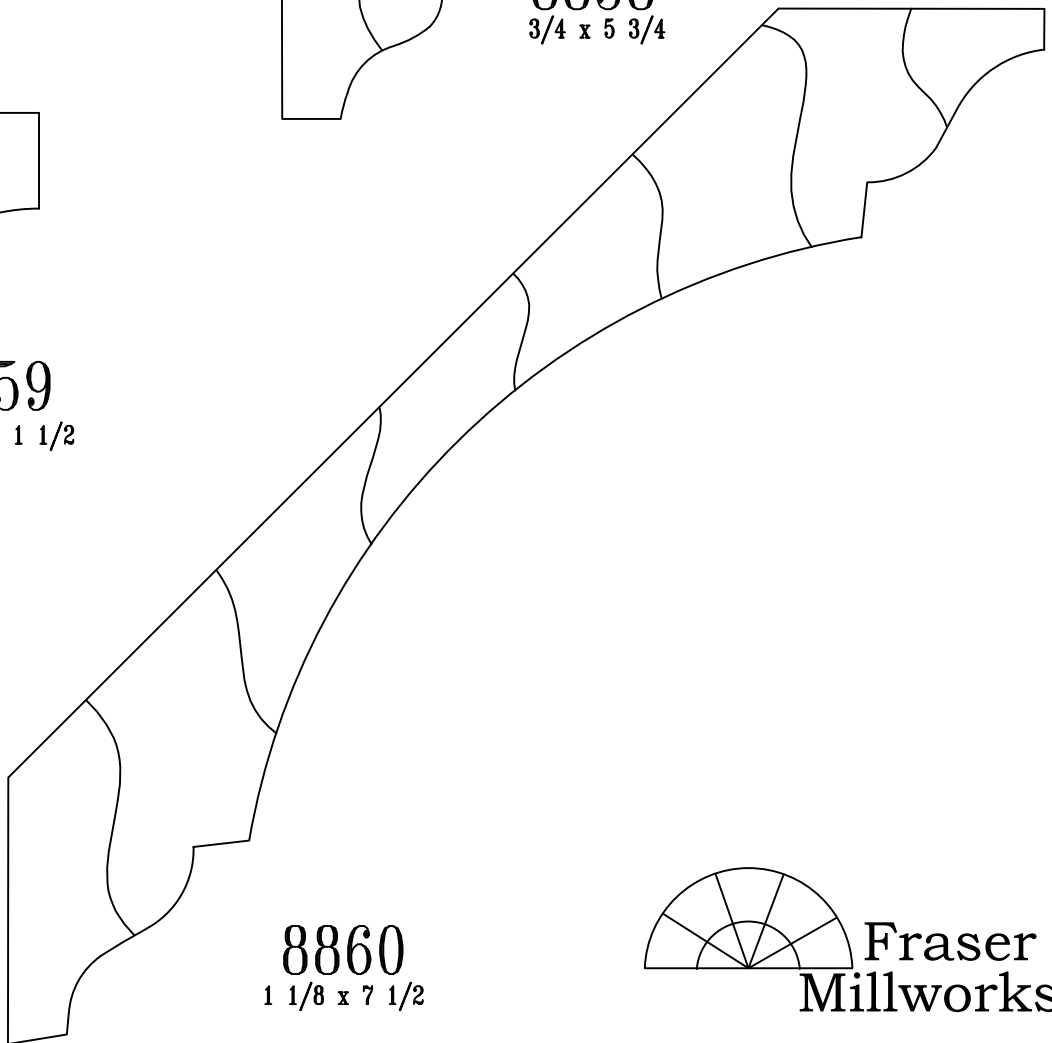

8860
1 1/8 x 7 1/2

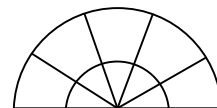

**Fraser
Millworks**

Cove

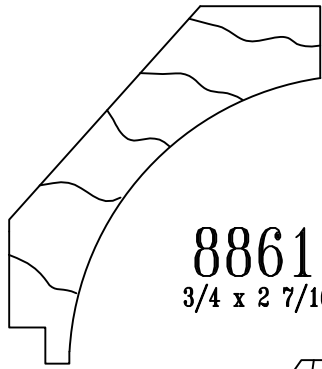

8861
 $3/4 \times 2 \ 7/16$

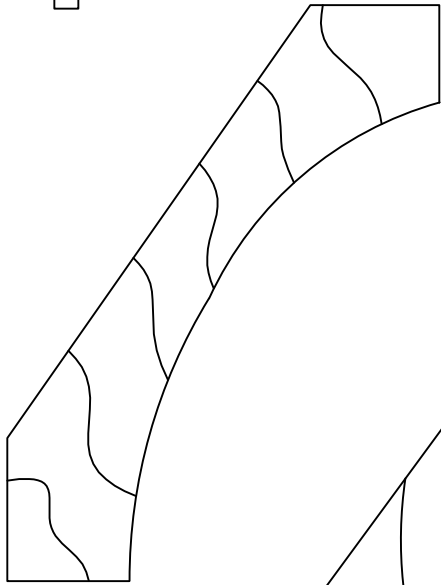

8862
 $15/16 \times 3 \ 3/4$

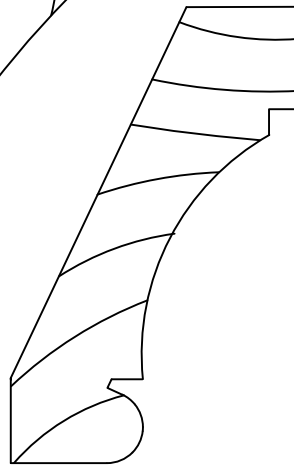

8866
 $3/4 \times 2 \ 13/16$

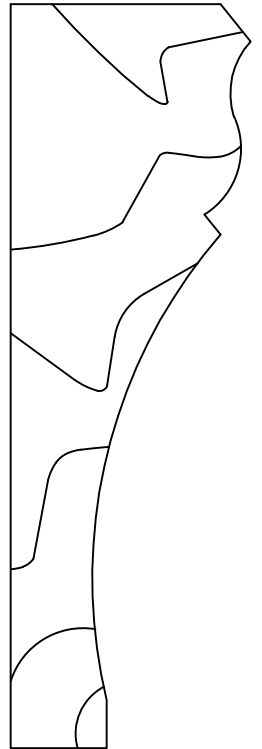

8864
 $1 \ 1/4 \times 3 \ 7/8$

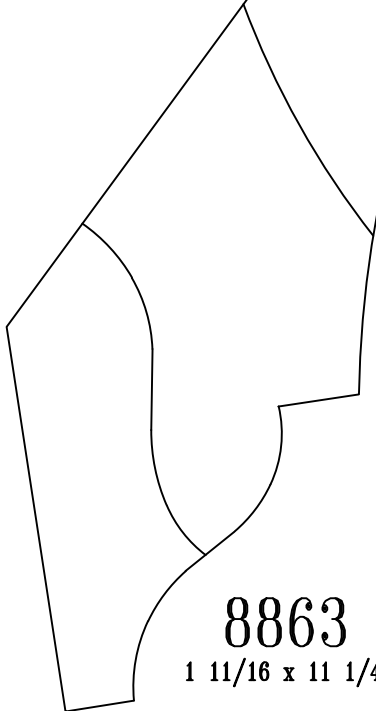

8863
 $1 \ 11/16 \times 11 \ 1/4$

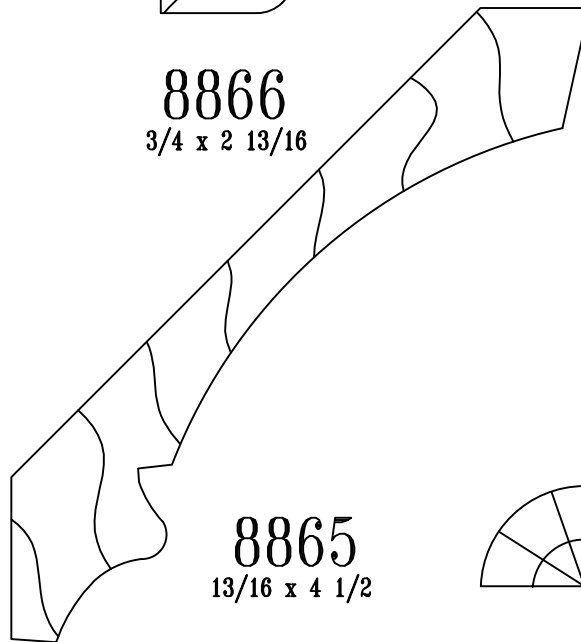

8865
 $13/16 \times 4 \ 1/2$

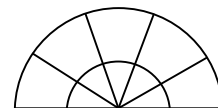

Fraser
Millworks

Cove

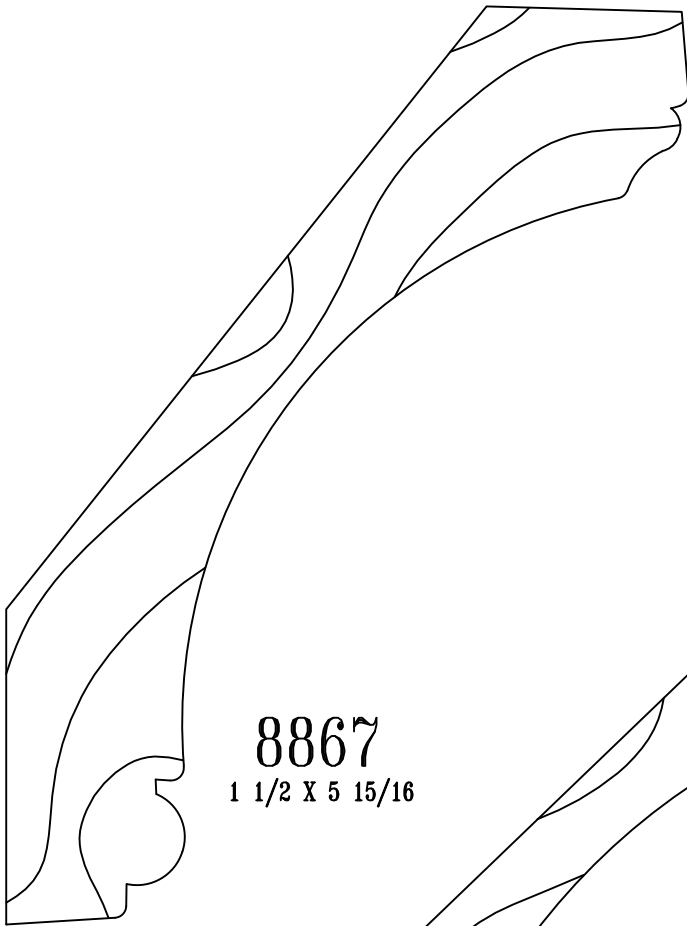

8867
1 1/2 X 5 15/16

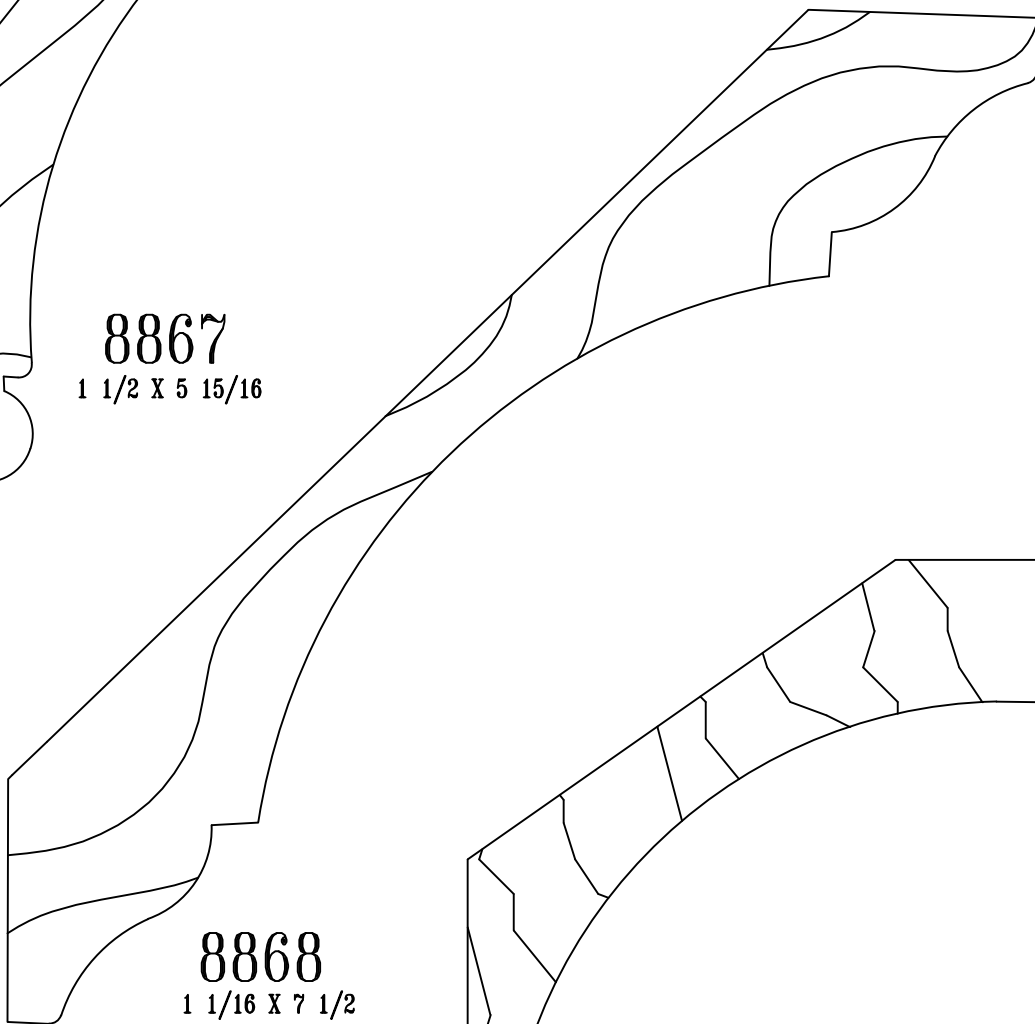

8868
1 1/16 X 7 1/2

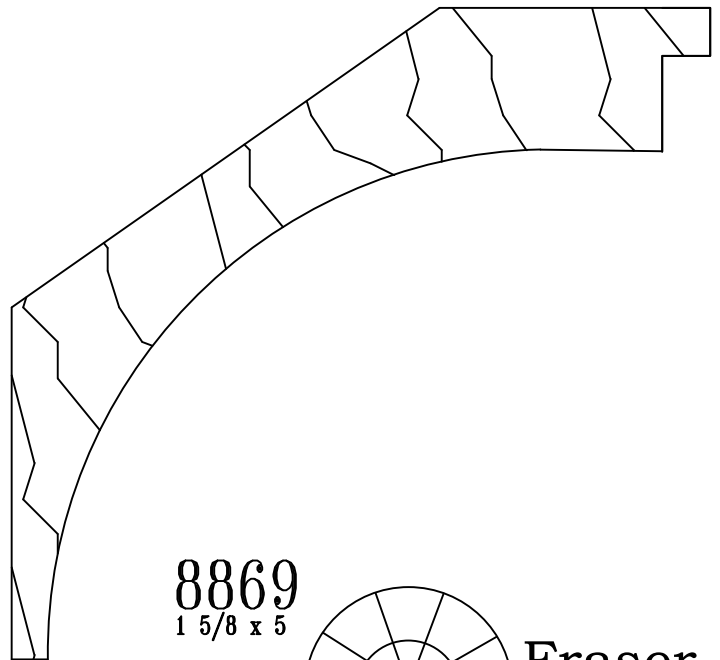

8869
1 5/8 x 5

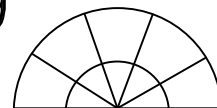

**Fraser
Millworks**

Cove

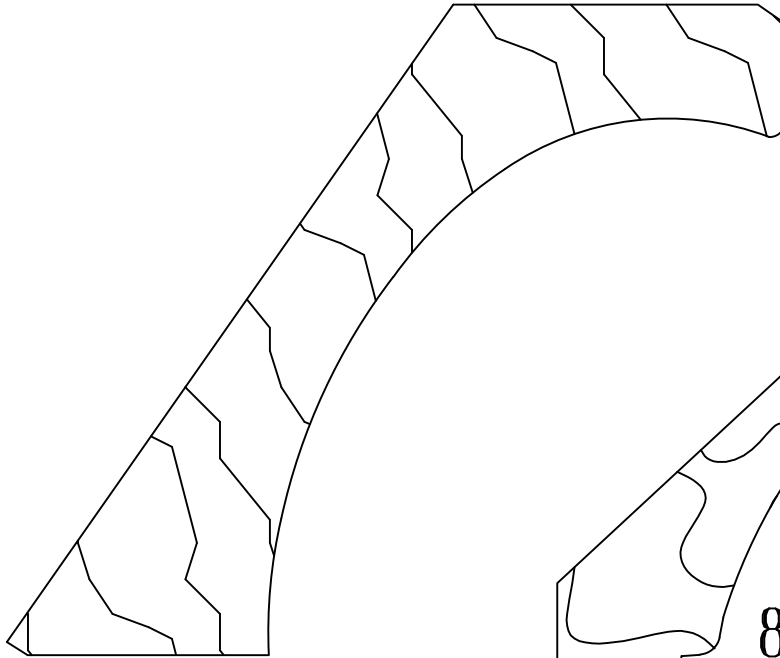

8870
1 3/4 x 5

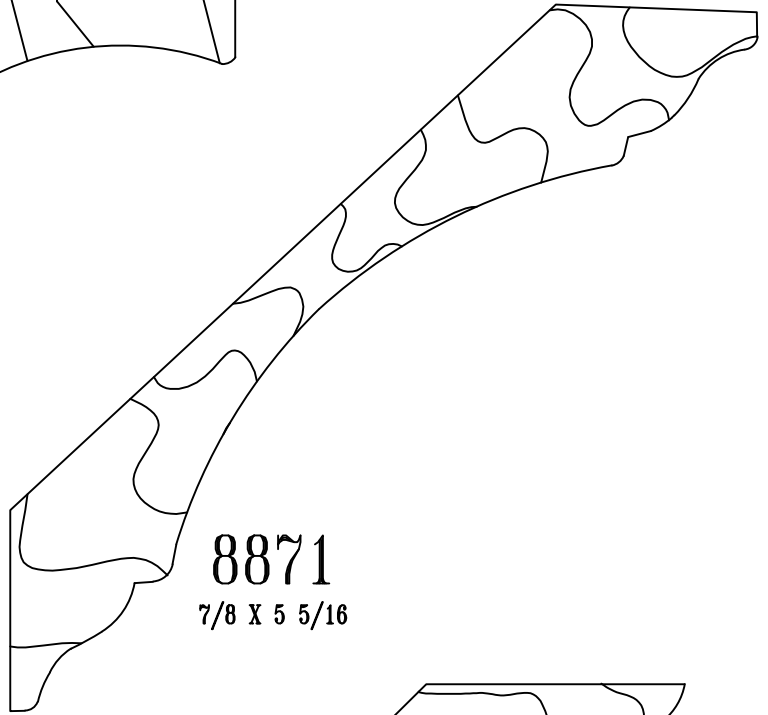

8871
7/8 X 5 5/16

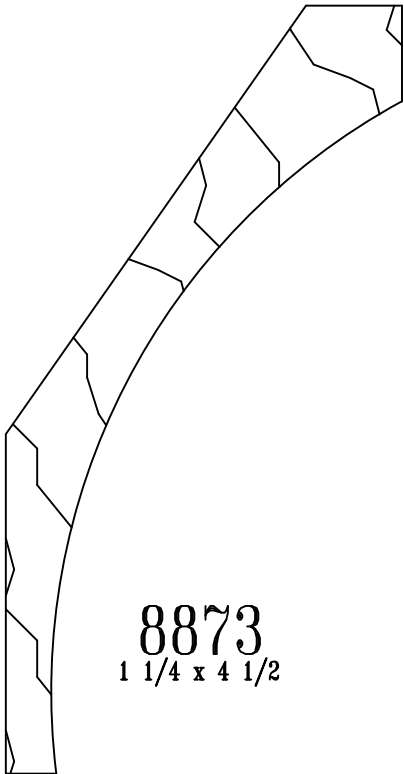

8873
1 1/4 x 4 1/2

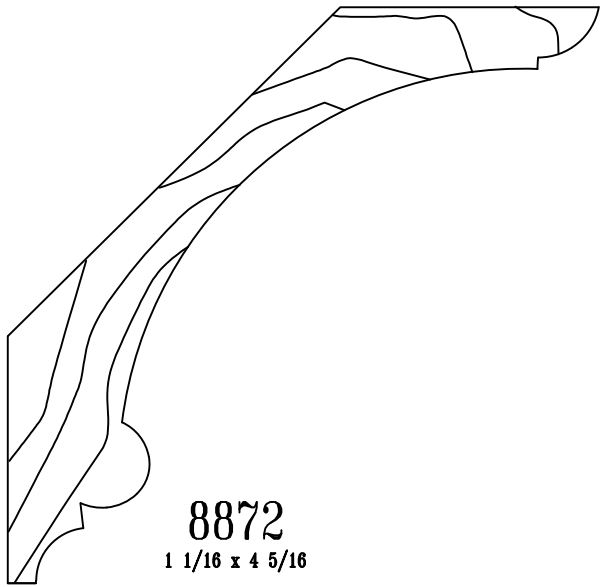

8872
1 1/16 x 4 5/16

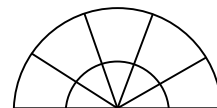

**Fraser
Millworks**

Cove

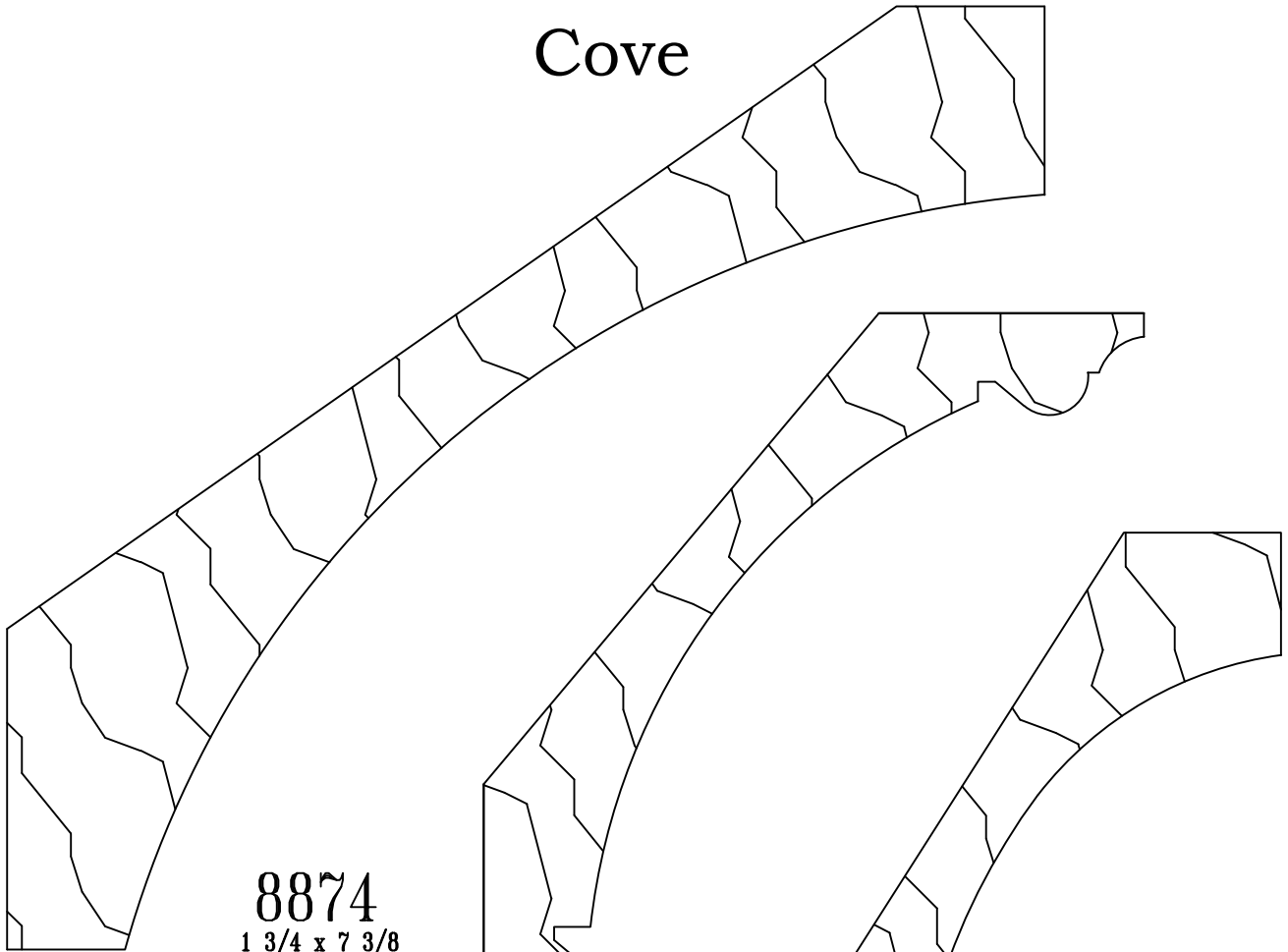

8874
1 3/4 x 7 3/8

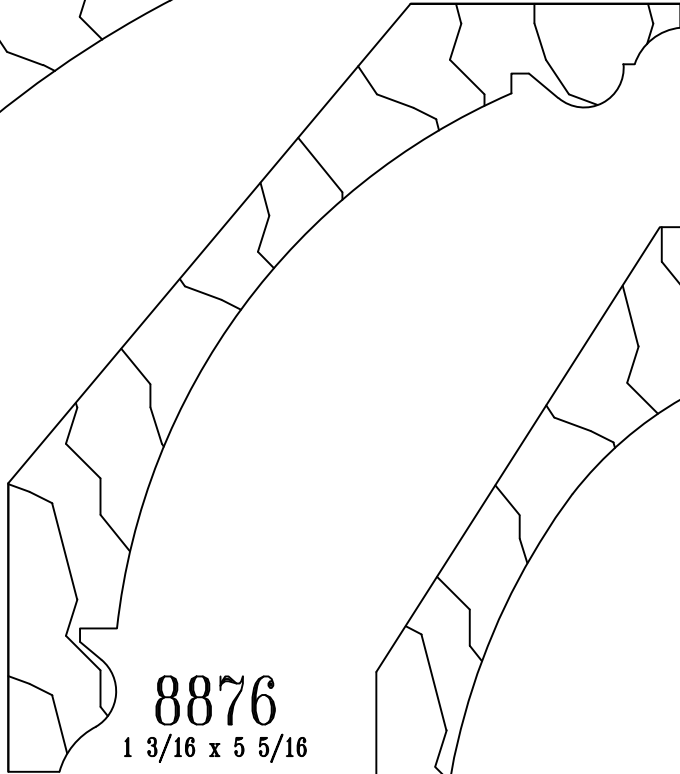

8876
1 3/16 x 5 5/16

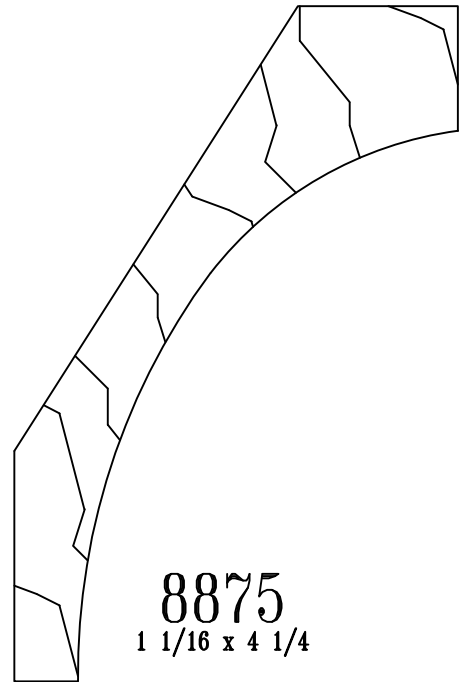

8875
1 1/16 x 4 1/4

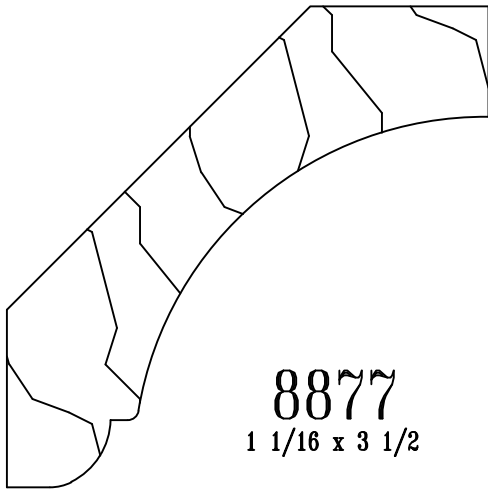

8877
1 1/16 x 3 1/2

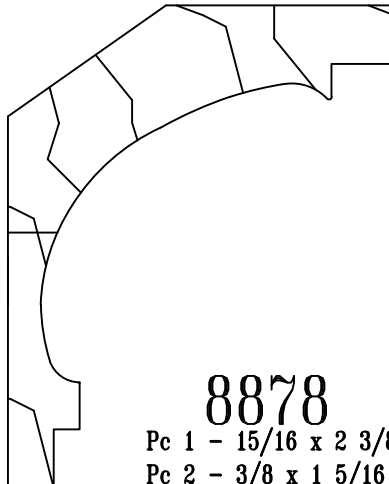

8878
Pc 1 - 15/16 x 2 3/8
Pc 2 - 3/8 x 1 5/16

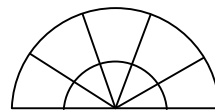

**Fraser
Millworks**

Cove

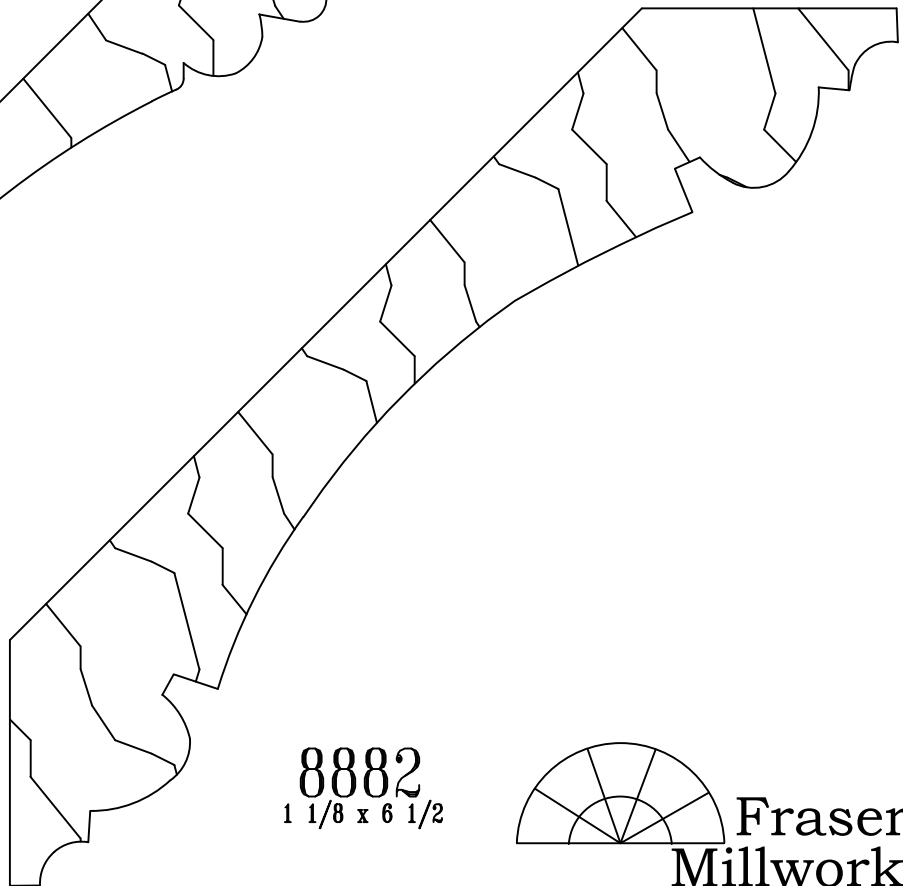
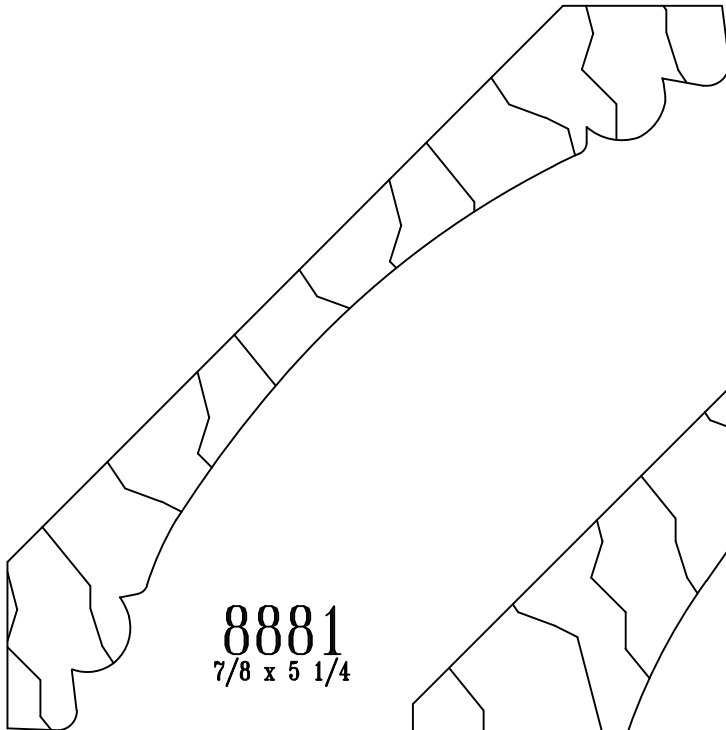
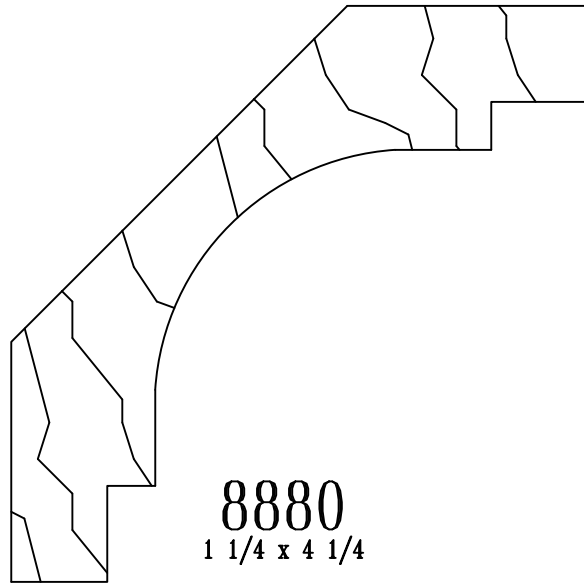
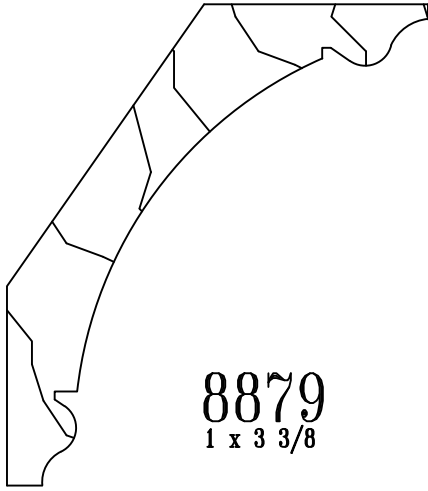

Fraser
Millworks